

A smile is a curve that sets everything straight

www.b-dental.be



 **B-DENTAL**
ORTHODONTIC SUPPLIES

**Een partner die uw
vertrouwen verdient!**

**Un partenaire qui
mérite votre confiance!**

We go for
QUALITY



ONS BEDRIJF

B-Dental werd opgericht in januari 2007 en is actief in de distributie van orthodontiematerialen in België en Luxemburg. Daarbij proberen wij zo goed mogelijk de wensen en belangen van onze klanten in orthodontie, logopedie en mini-implantologie te behartigen.

Indien u vragen of suggesties heeft, aarzelt u zeker niet met ons contact op te nemen.

VISION & VALUES B-DENTAL

3 Kenmerken die het succes van B-Dental bepalen:

- Kennis en ervaring
- Vertrouwen en wederzijds respect
- Focus op kwaliteit en noden

Kennis en ervaring

Elke persoon in ons team heeft zijn plaats en de nodige ervaring om van B-Dental een partner te maken die uw vertrouwen verdient. Met een passie voor orthodontie en de kennis die onze mensen hebben kunnen we streven naar de beste oplossing voor u.

Vertrouwen en wederzijds respect

Vertrouwen en wederzijds respect moet men verdienen. B-Dental streeft er naar om een solide relatie op te bouwen met zowel de leveranciers als onze klanten. Wederzijds respect en betrouwbaarheid zijn essentieel voor ons.

Focus op kwaliteit en noden

Als het om gezondheid gaat is kwaliteit het sleutelwoord. Wie voor B-Dental kiest, kiest voor kwalitatieve producten. Bij B-Dental gaat een breed productaanbod hand in hand met een klantvriendelijke prijsstructuur. Wij streven naar een eerlijke prijs op maat voor uw praktijk! Met de juiste prijs en de verscheidenheid aan producten kan B-Dental perfect voldoen aan uw noden.

NOTRE ENTREPRISE

B-Dental a été fondée en janvier 2007 et est active dans la distribution de matériel orthodontique en Belgique et au Luxembourg. Nous essayons de répondre au mieux aux désirs et intérêts de nos clients en orthodontie, logopédie et mini-implantologie.

Si vous avez des questions ou suggestions, n'hésitez surtout pas à nous contacter.

VISION & VALUES B-DENTAL

3 caractéristiques qui déterminent le succès de B-Dental:

- Connaissance et expérience
- Confiance et respect mutuel
- La qualité de nos produits et vos besoins

Connaissance et expérience

Chaque personne, dans notre équipe, a sa place et l'expérience nécessaire pour faire de B-Dental un partenaire qui mérite votre confiance. Grâce à notre passion pour l'orthodontie et notre connaissance, nous pouvons vous offrir la meilleure solution.

Confiance et respect mutuel

La confiance et le respect mutuel se méritent! B-Dental s'efforce d'établir des relations solides avec les fournisseurs et les clients. La fiabilité et le respect mutuel sont deux points essentiels à nos yeux.

La qualité de nos produits et vos besoins

Quand il s'agit de santé, la qualité est le mot clé. Celui qui opte pour B-Dental, opte pour des produits de haute qualité. B-Dental offre une large gamme de produits qui va de pair avec une structure de prix conviviaux. Un prix honnête et des remises sur mesure pour votre cabinet, B-Dental répond ainsi à vos besoins.

INHOUDELIJKE TABEL / TABLEAU DE CONTENU

	Metalen brackets / Brackets Métalliques	1	1.1-1.32
	Rhodium brackets / Brackets Rhodium	2	2.1-2.10
	Keramische brackets / Brackets Céramiques	3	3.1-3.12
	Kleef- & Weldable tubes / Tubes à coller & à souder	4	4.1-4.28
	Banden / Bagues	5	5.1-5.6
	Lijmen / Colles	6	6.1-6.9
	Draden / Fils	7	7.1-7.28
	Elastieken / Élastiques	8	8.1-8.6
	Springs & Auxiliaries / Ressorts & Auxiliaries	9	9.1-9.7
	Clear X & intra-oral scanner	10	10.1-10.4
	Aligner Supplies & Burs / Produits pour Aigneurs & Fraises	11	11.1-11.10
	Extra-Orale Tractie / Traction Extra-Oral	12	12.1-12.4
	Instrumenten / Instruments	13	13.1-13.21
	Myofunctional / Myofunctionnelle	14	14.1-14.14
	Afdrukmetaal / Matériel pour empreintes	15	15.1-15.6
	Fotografie / Photographie	16	16.1-16.5
	Patient Supplies / Produits pour patients	17	17.1-17.6
	Hygiëne / Hygiène	18	18.1-18.6
	Labo / produits Labo	19	19.1-19.12
	Mini-Implants / Mini-Implants	20	20.1-20.3







Metalen/Métalliques
BRACKETS



LEGEND mini Type Roth*



LEGEND mini Type Roth MAXILLARY

Tooth	I/O mm	Torque	Angulation	Rotation	P/N			
					.018"		.022"	
					R	L	R	L
U 1	.25	12°	5°	0°	31-1110-0010	31-1210-0010	31-2110-0010	31-2210-0010
U 2	.78	8°	9°	0°	31-1120-0010	31-1220-0010	31-2120-0010	31-2220-0010
U 2/Hk	.78	8°	9°	0°	31-112D-0010	31-122D-0010	31-212D-0010	31-222D-0010
U 3	.25	2°	10°	4°m	31-1130-0010	31-1230-0010	31-2130-0010	31-2230-0010
U 3/Hk	.25	2°	10°	4°m	31-113D-0010	31-123D-0010	31-213D-0010	31-223D-0010
U 4	.37	-7°	0°	2°d	31-1140-0010	31-1240-0010	31-2140-0010	31-2240-0010
U 4/Hk	.37	-7°	0°	2°d	31-114M-0010	31-124M-0010	31-214M-0010	31-224M-0010
U 4/Hk, Off. Base	.37	-7°	0°	0°	—	—	31-214M-0013	31-224M-0013
U 4-5/Off. Base	.37	-7°	0°	0°	31-1540-0013	31-1540-0013	31-2540-0013	31-2540-0013
U 5	.48	-7°	0°	2°d	31-1150-0010	31-1250-0010	31-2150-0010	31-2250-0010
U 5/Hk	.48	-7°	0°	2°d	31-115M-0010	31-125M-0010	31-215M-0010	31-225M-0010

MANDIBULAR

Tooth	I/O mm	Torque	Angulation	Rotation	P/N			
					.018"		.022"	
					R	L	R	L
L 1-2	.97	-1°	0°	0°	31-1610-0010	31-1610-0010	31-2610-0010	31-2610-0010
L 3	.25	-11°	7°	2°m	31-1430-0010	31-1330-0010	31-2430-0010	31-2330-0010
L 3/Hk	.25	-11°	7°	2°m	31-143D-0010	31-133D-0010	31-243D-0010	31-233D-0010
L 4	.28	-17°	0°	4°d	31-1440-0010	31-1340-0010	31-2440-0010	31-2340-0010
L 4/Off. Base	.28	-17°	0°	0°	31-1640-0013	31-1640-0013	31-2640-0013	31-2640-0013
L 4/Hk	.28	-17°	0°	4°d	31-144D-0010	31-134D-0010	31-244D-0010	31-234D-0010
L 4/Hk, Off. Base	.28	-17°	0°	0°	31-144D-0013	31-134D-0013	31-244D-0013	31-234D-0013
L 5	.33	-22°	0°	4°d	31-1450-0010	31-1350-0010	31-2450-0010	31-2350-0010
L 5/Off. Base	.33	-22°	0°	0°	31-1650-0013	31-1650-0013	31-2650-0013	31-2650-0013
L 5/Hk	.33	-22°	0°	4°d	31-145D-0010	31-135D-0010	31-245D-0010	31-235D-0010
L 5/Hk, Off. Base	.33	-22°	0°	0°	—	—	31-245D-0013	31-235D-0013

Metalen brackets zijn verpakt per 10 stuks / Les brackets métalliques sont emballés par 10 pcs

GC Orthodontics version of the **MBT™ System** prescription (McLaughlin, Bennet or Trevisi) and is not a copy of existing system. No endorsement by the Drs McLaughlin, Bennett or Trevisi is implied.

GC Orthodontics version of the **Roth System** prescription and is not a copy of existing system. No endorsement by Dr Roth is implied.

GC Orthodontics version of the **Andrews System** prescription and is not a copy of existing system. No endorsement by Dr Andrews is implied.

GC Orthodontics version of the **BiDimensional** prescription and is not a copy of existing system. No endorsement by Dr Gianelly is implied.

GC Orthodontics version of the **Bio-Progressive** prescription and is not a copy of existing system. No endorsement by Dr Ricketts is implied.



LEGEND mini Type MBT*



LEGEND mini Type MBT* MAXILLARY

Tooth	Torque	Angulation	Rotation	P/N			
				.018"		.022"	
				R	L	R	L
U 1	.25	17°	4°	31-1110-0020	31-1110-0020	31-2110-0020	31-2210-0020
U 2	.78	10°	8°	31-1120-0020	31-1220-0020	31-2120-0020	31-2220-0020
U 3	.25	-7°	8°	31-1130-0020	31-1230-0020	31-2130-0020	31-2230-0020
U 3/Hk	.25	0°	8°	31-113D-0021	31-123D-0021	31-213D-0021	31-223D-0021
U 3/Hk	.25	-7°	8°	31-113D-0020	31-123D-0020	31-213D-0020	31-223D-0020
U 4	.37	-7°	0°	31-1540-0020	31-1540-0020	31-2540-0020	31-2540-0020
U 4/Hk	.37	-7°	0°	31-114D-0020	31-124D-0020	31-214D-0020	31-224D-0020
U 5	.48	-7°	0°	31-1550-0020	31-1550-0020	31-2550-0020	31-2550-0020
U 5/Hk	.48	-7°	0°	31-115D-0020	31-125D-0020	31-215D-0020	31-225D-0020

MANDIBULAR

Tooth	Torque	Angulation	Rotation	P/N			
				.018"		.022"	
				R	L	R	L
L 1-2	.97	-6°	0°	31-1610-0020	31-1610-0020	31-2610-0020	31-2610-0020
L 1-2/(Optional)	.97	-1°	2°	31-1410-0045	31-1310-0045	—	—
L 3	.25	-6°	3°	31-1430-0020	31-1330-0020	31-2430-0020	31-2330-0020
L 3/Hk	.25	0°	3°	31-143D-0021	31-133D-0021	31-243D-0021	31-233D-0021
L 3/Hk	.25	-6°	3°	31-143D-0020	31-133D-0020	31-243D-0020	31-233D-0020
L 4	.28	-12°	2°	31-1440-0020	31-1340-0020	31-2440-0020	31-2340-0020
L 4/Offset Base	.28	-12°	2°	31-1440-0073	31-1340-0073	31-2440-0073	31-2340-0073
L 4 /Hk/Offset Base	.28	-12°	2°	31-144D-0073	31-134D-0073	31-244D-0073	31-234D-0073
L 4/Hk	.28	-12°	2°	31-144D-0020	31-134D-0020	31-244D-0020	31-234D-0020
L 5	.33	-17°	2°	31-1450-0020	31-1350-0020	31-2450-0020	31-2350-0020
L 5/Offset Base	.33	-17°	2°	31-1450-0073	31-1350-0073	31-2450-0073	31-2350-0073
L 5 /Hk/Offset Base	.33	-17°	2°	31-145D-0073	31-135D-0073	31-245D-0073	31-235D-0073
L 5/Hk	.33	-17°	2°	31-145D-0020	31-135D-0020	31-245D-0020	31-235D-0020

Metalen brackets zijn verpakt per 10 stuks / Les brackets métalliques sont emballés par 10 pcs

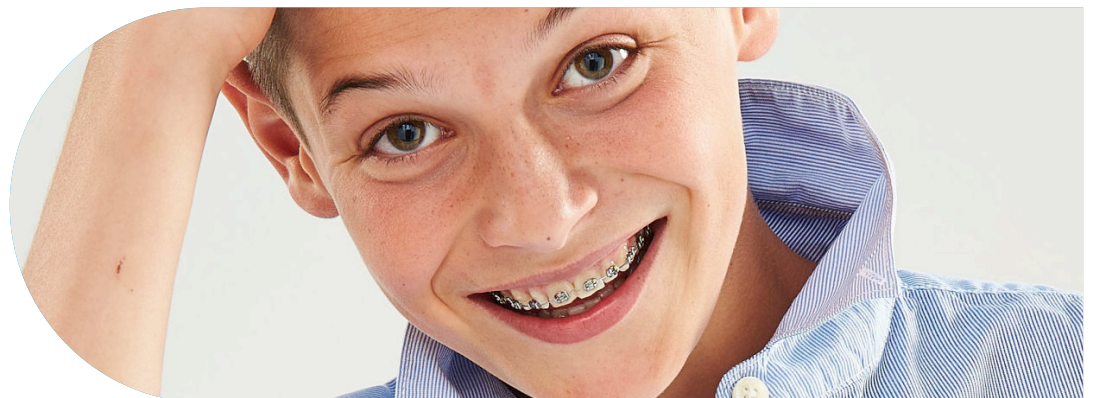



LEGEND mini V-slot Type Roth*



LEGEND mini V-Slot Type Roth MAXILLARY

Tooth	I/O mm	Torque	Angulation	Rotation	P/N			
					.018"		.022"	
					R	L	R	L
U 1	.70	12°	5°	0°	31-1110-0034	31-1210-0034	31-2110-0034	31-2210-0034
U 2	.97	8°	9°	0°	31-1120-0034	31-1220-0034	31-2120-0034	31-2220-0034
U 3	.56	-2°	7°	0°	31-1130-0034	31-1230-0034	31-2130-0034	31-2230-0034
U 3/Hk	.56	-2°	7°	0°	31-113D-0034	31-123D-0034	31-213D-0034	31-223D-0034
U 4-5	.56	-7°	0°	0°	31-1540-0034	31-1540-0034	31-2540-0034	31-2540-0034
U 4-5/Off. Base	.56	-7°	0°	0°	31-1540-0035	31-1540-0035	31-2540-0035	31-2540-0035
U 4-5/Hk	.56	-7°	0°	0°	31-114M-0034	31-124M-0034	31-214M-0034	31-224M-0034

MANDIBULAR

Tooth	I/O mm	Torque	Angulation	Rotation	P/N			
					.018"		.022"	
					R	L	R	L
L 1-2	.97	0°	0°	0°	31-1610-0034	31-1610-0034	31-2610-0034	31-2610-0034
L 3	.56	-5°	7°	0°	31-1430-0034	31-1330-0034	31-2430-0034	31-2330-0034
L 3/Hk	.56	-5°	7°	0°	31-143D-0034	31-133D-0034	31-243D-0034	31-233D-0034
L 4	.56	-11°	0°	0°	31-1640-0034	31-1640-0034	31-2640-0034	31-2640-0034
L 4/Hk	.56	-11°	0°	0°	31-144D-0034	31-134D-0034	31-244D-0034	31-234D-0034
L 4/Off. Base	.56	-11°	0°	0°	31-1640-0035	31-1640-0035	31-2640-0035	31-2640-0035
L 4/Hk, Off. Base	.56	-11°	0°	0°	31-144D-0035	31-134D-0035	31-244D-0035	31-234D-0035
L 5	.56	-17°	0°	0°	31-1650-0034	31-1650-0034	31-2650-0034	31-2650-0034
L 5/Hk	.56	-17°	0°	0°	31-145D-0034	31-135D-0034	31-245D-0034	31-235D-0034
L 5/Off. Base	.56	-17°	0°	0°	31-1650-0035	31-1650-0035	31-2650-0035	31-2650-0035
L 5/Hk, Off. Base	.56	-17°	0°	0°	31-145D-0035	31-135D-0035	31-245D-0035	31-235D-0035

Metalen brackets zijn verpakt per 10 stuks / Les brackets métalliques sont emballés par 10 pcs

LEGEND mini Kits

LEGEND mini Kits

Prescription	Upper Arch	Lower Arch	With Hook	P/N	
				.018"	.022"
Type Roth	5-5	5-5	—	31-1CC0-0010	31-2CC0-0010
Type Roth	5-5	5-5	3	31-1CC3-0010	31-2CC3-0010
Type Roth	5-5	5-5	3,4,5	31-1CC5-0010	31-2CC5-0010
Type MBT*	5-5	5-5	—	31-1CC0-0020	31-2CC0-0020
Type MBT*	5-5	5-5	3	31-1CC3-0020	31-2CC3-0020
Type MBT*	5-5	5-5	3,4,5	31-1CC5-0020	31-2CC5-0020



LEGEND mini V-slot Type BiDimensional*



LEGEND mini V-Slot BiDimensional MAXILLARY

Tooth	I/Omm	Torque(°)	Angulation(°)	Rotation(°)	P/N			
					.018"		.022"	
					R	L	R	L
U 1	.70	12°	5°	0°	31-1110-0034	31-1210-0034	—	—
U 2	.97	8°	9°	0°	31-1120-0034	31-1220-0034	—	—
U 3	.56	0°	7°	0°	—	—	31-2130-0040	31-2230-0040
U 3/Hk	.56	0°	7°	0°	—	—	31-213D-0040	31-223D-0040
U 4-5	.56	0°	0°	0°	—	—	31-2540-0040	31-2540-0040
U 4-5/Hk	.56	0°	0°	0°	—	—	31-215M-0040	31-225M-0040

MANDIBULAR

Tooth	I/Omm	Torque(°)	Angulation(°)	Rotation(°)	P/N			
					.018"		.022"	
					R	L	R	L
L 1-2	.97	0°	0°	0°	31-1610-0034	31-1610-0034	—	—
L 3	.56	0°	5°	0°	—	—	31-2430-0040	31-2330-0040
L 3/Hk	.56	0°	5°	0°	—	—	31-243D-0040	31-233D-0040
L 4-5	.56	0°	0°	0°	—	—	31-2640-0040	31-2640-0040
L 4-5/Hk	.56	0°	0°	0°	—	—	31-244D-0040	31-234D-0040

Metalen brackets zijn verpakt per 10 stuks / Les brackets métalliques sont emballés par 10 pcs

LEGEND mini Type Bio-Progressive*

LEGEND mini Bio-Progressive MAXILLARY

Tooth	I/O mm	Torque(°)	Angulation(°)	Rotation(°)	P/N	
					.018"	
					R	L
U 1	.25	22°	5°	0°	31-1110-0027	31-1210-0027
U 2	.25	13°	9°	0°	31-1120-0011	31-1220-0011
U 3/Hk	.25	7°	5°	0°	31-113D-0027	31-123D-0027
U 4-5	.40	0°	0°	0°	31-1540-0025	31-1540-0025

MANDIBULAR

Tooth	I/O mm	Torque(°)	Angulation(°)	Rotation(°)	P/N	
					.018"	
					R	L
L 1-2	.97	-1°	0°	0°	31-1610-0010	31-1610-0010
L 3/Hk	.25	7°	5°	0°	31-143D-0027	31-133D-0027
L 4-5	.40	0°	0°	0°	31-1640-0025	31-1640-0025

Metalen brackets zijn verpakt per 10 stuks / Les brackets métalliques sont emballés par 10 pcs



LEGEND medium Type Roth*



LEGEND medium Type Roth MAXILLARY

Tooth	I/O mm	Torque	Angulation	P/N			
				.018"		.022"	
				R	L	R	L
U 1	.25	12°	5°	32-1110-0010	32-1210-0010	32-2110-0010	32-2210-0010
U 1	.25	17°	5°	—	—	32-2110-0011	32-2210-0011
U 2	.78	8°	9°	32-1120-0010	32-1220-0010	32-2120-0010	32-2220-0010
U 2/Hk	.78	8°	9°	32-112D-0010	32-122D-0010	32-212D-0010	32-222D-0010
U 3	.25	2°	10°	32-1130-0010	32-1230-0010	32-2130-0010	32-2230-0010
U 3/Hk	.25	2°	10°	32-113D-0010	32-123D-0010	32-213D-0010	32-223D-0010
U 4	.37	-7°	0°	32-1540-0010	32-1540-0010	32-2540-0010	32-2540-0010
U4/Univ.	.37	-7°	0°	32-1540-0011	32-1540-0011	—	—
U 4/Hk	.37	-7°	0°	32-114M-0010	32-124M-0010	32-214M-0010	32-224M-0010
U 4/Hk/Off. Base	.37	-7°	0°	—	—	32-214M-0013	32-224M-0013
U 4-5/Off. B.	.37	-7°	0°	32-1540-0013	32-1540-0013	32-2540-0013	32-2540-0013
U 5	.48	-7°	0°	32-1550-0010	32-1550-0010	32-2550-0010	32-2550-0010
U 5/Hk	.48	-7°	0°	32-115M-0010	32-125M-0010	32-215M-0010	32-225M-0010
U 5/Hk/Off. Base	.48	-7°	0°	—	—	32-215M-0013	32-225M-0013

MANDIBULAR

Tooth	I/O mm	Torque	Angulation	P/N			
				.018"		.022"	
				R	L	R	L
L 1	.97	-5°	0°	32-1610-0011	32-1610-0011	32-2610-0011	32-2610-0011
L 1-2	.97	-1°	0°	32-1610-0010	32-1610-0010	32-2610-0010	32-2610-0010
L 1-2/Hk	.97	-1°	0°	—	—	32-241D-0010	32-231D-0010
L 3	.25	-11°	7°	32-1430-0010	32-1330-0010	32-2430-0010	32-2330-0010
L 3/Hk	.25	-11°	7°	32-143D-0010	32-133D-0010	32-243D-0010	32-233D-0010
L 4	.28	-17°	0°	32-1640-0010	32-1640-0010	32-2640-0010	32-2640-0010
L 4/Hk	.28	-17°	0°	32-144D-0010	32-134D-0010	32-244D-0010	32-234D-0010
L 4/Off. B.	.28	-17°	0°	32-1640-0013	32-1640-0013	32-2640-0013	32-2640-0013
L 4/Hk, Off. B.	.28	-17°	0°	32-144D-0013	32-134D-0013	32-244D-0013	32-234D-0013
L 5	.33	-22°	0°	32-1650-0010	32-1650-0010	32-2650-0010	32-2650-0010
L 5/Hk	.33	-22°	0°	32-145D-0010	32-135D-0010	32-245D-0010	32-235D-0010
L 5/Off. B.	.33	-22°	0°	32-1650-0013	32-1650-0013	32-2650-0013	32-2650-0013
L 5/Hk, Off. B.	.33	-22°	0°	32-145D-0013	32-135D-0013	32-245D-0013	32-235D-0013

Metalen brackets zijn verpakt per 10 stuks / Les brackets métalliques sont emballés par 10 pcs



LEGEND medium Type MBT*



LEGEND medium Type MBT* MAXILLARY

Tooth	I/O mm	Torque	Angulation	P/N			
				.018"		.022"	
				R	L	R	L
U 1	.25	17°	4°	32-1110-0020	32-1210-0020	32-2110-0020	32-2210-0020
U 2	.78	10°	8°	32-1120-0020	32-1220-0020	32-2120-0020	32-2220-0020
U 3	.25	-7°	8°	32-1130-0020	32-1230-0020	32-2130-0020	32-2230-0020
U 3/Hk	.25	-7°	8°	32-113D-0020	32-123D-0020	32-213D-0020	32-223D-0020
U 3/Hk/(Optional)	.25	0°	8°	32-113D-0021	32-123D-0021	32-213D-0021	32-223D-0020
U 4	.37	-7°	0°	32-1540-0020	32-1540-0020	32-2540-0020	32-2540-0020
U 4/Hk	.37	-7°	0°	32-114M-0020	32-124M-0020	32-214M-0020	32-224M-0020
U 5	.48	-7°	0°	32-1550-0020	32-1550-0020	32-2550-0020	32-2550-0020
U 5/Hk	.48	-7°	0°	32-115M-0020	32-125M-0020	32-215M-0020	32-225M-0020

MANDIBULAR

Tooth	I/O mm	Torque	Angulation	P/N			
				.018"		.022"	
				R	L	R	L
L 1-2	.97	-6°	0°	32-1610-0020	32-1610-0020	32-2610-0020	32-2610-0020
L 3	.30	-6°	3°	32-1430-0020	32-1330-0020	32-2430-0020	32-2330-0020
L 3/Hk	.30	-6°	3°	32-143D-0020	32-133D-0020	32-243D-0020	32-233D-0020
L 3/Hk/(Optional)	.30	0°	8°	-	-	32-243D-0021	32-233D-0021
L 4	.50	-12°	2°	32-1440-0020	32-1340-0020	32-2440-0020	32-2340-0020
L 4/Hk	.50	-12°	2°	32-144D-0020	32-134D-0020	32-244D-0020	32-234D-0020
L 4/Offset Base	.50	-12°	2°	32-1440-0073	32-1340-0073	32-2440-0073	32-2340-0073
L 4/Hk/Offset Base	.50	-12°	2°	32-144D-0073	32-134D-0073	32-244D-0073	32-234D-0073
L 5	.50	-17°	2°	32-1450-0020	32-1350-0020	32-2450-0020	32-2350-0020
L 5/Hk	.50	-17°	2°	32-145D-0020	32-135D-0020	32-245D-0020	32-235D-0020
L 5/Offset Base	.50	-17°	2°	32-1450-0073	32-1350-0073	32-2450-0073	32-2350-0073
L 5/Hk/Offset Base	.50	-17°	2°	32-145D-0073	32-135D-0073	32-245D-0073	32-235D-0073

Metalen brackets zijn verpakt per 10 stuks / Les brackets métalliques sont emballés par 10 pcs





LEGEND medium Type Bio-Progressive*



LEGEND medium Bio-Progressive MAXILLARY

Tooth	I/O mm	Torque	Angulation	P/N			
				.018"		.022"	
				R	L	R	L
U 1	.25	22°	5°	32-1110-0027	32-1210-0027	32-2110-0027	32-2210-0027
U 2	.78	14°	9°	32-1120-0027	32-1220-0027	32-2120-0027	32-2220-0027
U 3	.25	7°	5°	32-1130-0027	32-1230-0027	32-2130-0027	32-2230-0027
U 3/Hk	.37	7°	5°	32-113D-0027	32-123D-0027	32-213D-0027	32-223D-0027
U 4-5	.48	0°	0°	32-1540-0027	32-1540-0027	—	—
U 4-5/Extra Torque	.48	-7°	0°	32-1540-0029	32-1540-0029	—	—
U 4-5/Hk	.48	0°	0°	32-114M-0027	32-124M-0027	—	—

MANDIBULAR

L 1-2	.97	-1°	0°	32-1610-0010	32-1610-0010	32-2610-0010	32-2610-0010
L 3	.25	7°	5°	32-1430-0027	32-1330-0027	32-2430-0027	32-2330-0027
L 3/Hk	.25	7°	5°	32-143D-0027	32-133D-0027	32-243D-0027	32-233D-0027
L 4-5	.28	0°	0°	32-1640-0027	32-1640-0027	—	—
L 4-5/Hk	.28	0°	0°	32-144D-0027	32-134D-0027	—	—
L 4/Extra Torque	.36	-11°	0°	32-1640-0029	32-1640-0029	—	—
L 5/Extra Torque	.36	-17°	0°	32-1650-0029	32-1650-0029	—	—

Metalen brackets zijn verpakt per 10 stuks / Les brackets métalliques sont emballés par 10 pcs

LEGEND medium V-slot Bio-Progressive* V-slot

LEGEND medium V-Slot Bio-Progressive V-Slot MAXILLARY

Tooth	I/O mm	Torque	Angulation	P/N			
				.018"		.022"	
				R	L	R	L
U 1	.41	22°	5°	32-1110-0028	32-1210-0028	32-2110-0028	32-2210-0028
U 2	.93	14°	9°	32-1120-0028	32-1220-0028	32-2120-0028	32-2220-0028
U 3/Hk	.36	7°	5°	32-113D-0028	32-123D-0028	32-213D-0028	32-223D-0028
U 4-5/univ.	.43	0°	0°	32-1540-0040	32-1540-0040	32-2540-0040	32-2540-0040

MANDIBULAR

L 1-2	1.09	0°	0°	32-1610-0034	32-1610-0034	32-2610-0034	32-2610-0034
L 3/Hk	.36	7°	5°	32-143D-0028	32-133D-0028	32-243D-0028	32-233D-0028
L 4/univ.	.36	-11°	0°	32-1640-0034	32-1640-0034	—	—
L 5/univ.	.36	-17°	0°	32-1650-0029	32-1650-0029	—	—

Metalen brackets zijn verpakt per 10 stuks / Les brackets métalliques sont emballés par 10 pcs



LEGEND medium

V-slot Type BiDimensional*



LEGEND medium V-Slot BiDimensional MAXILLARY

Tooth	I/O mm	Torque	Angulation	P/N			
				.018"		.022"	
				R	L	R	L
U 1	.41	12°	5°	32-1110-0034	32-1210-0034	32-2110-0034	32-2210-0034
U 1	.41	17°	5°	32-1110-0029	32-1210-0029	32-2110-0029	32-2210-0029
U 2	.93	8°	9°	32-1120-0034	32-1220-0034	32-2120-0034	32-2220-0034
U 3	.36	0°	7°	32-1130-0040	32-1230-0040	—	—
U 3	.36	-2°	7°	32-1130-0034	32-1230-0034	32-2130-0034	32-2230-0034
U 3/Hk	.36	0°	7°	32-113D-0040	32-123D-0040	32-213D-0040	32-223D-0040
U 3/Hk	.36	-2°	7°	32-113D-0034	32-123D-0034	32-213D-0034	32-223D-0034
U 4/Hk	.43	0°	0°	—	—	32-214M-0040	32-224M-0040
U 4-5	.43	0°	0°	32-1540-0040	32-1540-0040	32-2540-0040	32-2540-0040
U 4-5	.43	-7°	0°	32-1540-0034	32-1540-0034	32-2540-0034	32-2540-0034
U 4-5/Hk	.43	-7°	0°	32-114M-0034	32-124M-0034	32-214M-0034	32-224M-0034
U 4-5/Hk	.43	0°	0°	—	—	32-214M-0040	32-224M-0040
U 4-5/Off. Base	.43	-7°	0°	32-1540-0035	32-1540-0035	32-2540-0035	32-2540-0035

MANDIBULAR

Tooth	I/O mm	Torque	Angulation	P/N			
				.018"		.022"	
				R	L	R	L
L 1-2	1.09	0°	0°	32-1610-0034	32-1610-0034	32-2610-0034	32-2610-0034
L 1-2	1.09	-5°	0°	—	—	32-2610-0036	32-2610-0036
L 3	.36	-5°	7°	32-1430-0034	32-1330-0034	32-2430-0034	32-2330-0034
L 3/Hk	.36	-5°	7°	32-143D-0034	32-133D-0034	32-243D-0034	32-233D-0034
L 3/Hk	.36	0°	5°	—	—	32-243D-0040	32-233D-0040
L 4-5	.36	0°	0°	32-1640-0040	32-1640-0040	32-2640-0040	32-2640-0040
L 4	.36	-11°	0°	32-1640-0034	32-1640-0034	32-2640-0034	32-2640-0034
L 4/Off. Base	.36	-11°	0°	32-1640-0035	32-1640-0035	32-2640-0035	32-2640-0035
L 4/Hk	.36	-11°	0°	32-144D-0034	32-134D-0034	32-244D-0034	32-234D-0034
L 4/Hk	.36	0°	0°	—	—	32-244D-0040	32-234D-0040
L 4-5/Off. Base	.36	0°	0°	32-1640-0041	32-1640-0041	32-2640-0041	32-2640-0041
L 5	.36	-17°	0°	32-1650-0034	32-1650-0034	32-2650-0034	32-2650-0034
L 5/Hk	.36	-17°	0°	32-145D-0034	32-135D-0034	32-245D-0034	32-235D-0034
L 5/Off. Base	.36	-17°	0°	32-1650-0035	32-1650-0035	32-2650-0035	32-2650-0035

Metalen brackets zijn verpakt per 10 stuks / Les brackets métalliques sont emballés par 10 pcs

ACCESSORIES FOR V-SLOT BRACKETS

LEGEND MINI & MEDIUM HOOK FOR VERTICAL SLOTS

Description	P/N
Hook for V-Slot (Bag of 50)	69-1410-0000



Metalen/Métalliques BRACKETS



LEGEND medium Kits



LEGEND medium Kits

Prescription	Upper Arch	Lower Arch	With Hook	P/N	
				.018"	.022"
Type Roth	5-5	5-5	—	32-1CC0-0010	32-2CC0-0010
Type Roth	5-5	5-5	3	32-1CC3-0010	32-2CC3-0010
Type Roth	5-5	5-5	3,4,5	32-1CC5-0010	32-2CC5-0010
Extra Torque	5-5	5-5	3	32-1CC3-0030	32-2CC3-0030
Extra Torque	5-5	5-5	3,4,5	32-1CC5-0030	32-2CC5-0030
Type MBT*	5-5	5-5	—	32-1CC0-0020	32-2CC0-0020
Type MBT*	5-5	5-5	3	32-1CC3-0020	32-2CC3-0020
Type MBT*	5-5	5-5	3,4,5	32-1CC5-0020	32-2CC5-0020
Bio-Progressive	5-5	5-5	3	32-1CC3-0027	32-2CC3-0027
Bio-Progressive	5-5	5-5	3,4,5	32-1CC5-0027	32-2CC5-0027



EDGEWISE bracket



EDGEWISE BRACKET

		.018"	.022"
U1	Standard WD	29-1510-0059	29-2510-0059
	Standard WD/+ V-slot Univ	36-1510-0059	36-2510-0059
	15°T WD	29-1510-0063	-
	22°T WD	29-1510-0064	29-2510-0064
	22°T/+ V-slot WD	36-1510-0064	-
U2	Standaard MED	29-1520-0053	29-2520-0053
	14°T MED	29-1520-0065	29-2520-0065
	V-slot MED	36-1520-0053	36-2520-0053
	14°T/+V-slot MED	36-1520-0065	-
U/L3	Standard MED	29-1730-0053	29-2730-0053
	Standard WD	29-1730-0059	29-2730-0059
	7°T MED	29-1630-0068	-
	V-slot MED	36-1730-0053	36-2730-0053
	V-slot WD	36-1730-0059	36-2730-0059
	7°T/+V-slot WD	36-1730-0067	-
UL/LR3	+Hook WD	29-153D-0059	29-253D-0059
UR/LL3	+Hook WD	29-163D-0059	29-263D-0059
U4-5	Standard MED Offset Wings TP	29-1540-0057	29-2540-0057
	V-slot MED Offset Wings TP	36-1540-0057	36-2540-0057
U/L6-7	Standard WD	29-1760-0059	29-2760-0059
	Standard XWD	29-1760-0062	29-2760-0062
	V-slot Univ WD	36-1760-0059	36-2760-0059
	-10°T WD	-	29-2660-0066
L1-2	Low Profile NAR	29-1610-0050	29-2610-0050
	Low Profile MED TP	29-1610-0055	29-2610-0055
	Low Profile NAR TP	29-1610-0051	29-2610-0051
	V-slot MED	36-1610-0053	36-2610-0053
L4-5	Low Profile MED TP	29-1640-0055	29-2640-0055
	V-slot Univ. MED	36-1740-0053	36-2740-0053

Metalen brackets zijn verpakt per 10 stuks / Les brackets métalliques sont emballés par 10 pcs

AXCESS bracket

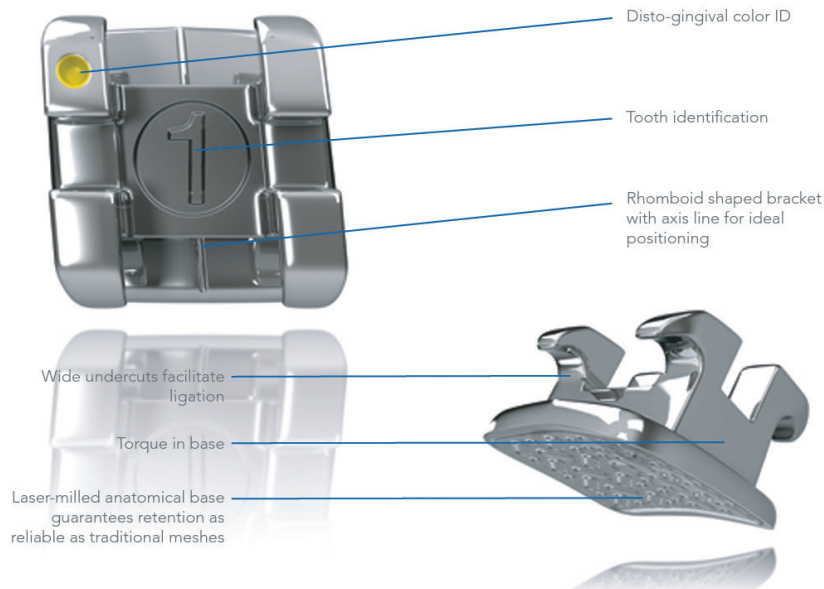

AXCESS, also manufactured by Tomy® in Japan, is an affordable bracket created from MIM (Metal Injection Molded) technology. All information (3 dimensions) is built into the bracket. Torque in base system. A laser-milled anatomical base guarantees retention as reliable as found in traditional meshes.

AXCESS Type Roth MAXILLARY

Tooth	I/O mm	Torque	Angulation	P/N			
				.018"		.022"	
				R	L	R	L
U 1	.73	12°	5°	30-1110-0010	30-1210-0010	30-2110-0010	30-2210-0010
U 2	1.19	8°	9°	30-1120-0010	30-1220-0010	30-2120-0010	30-2220-0010
U 3/Hk	.56	-2°	13°	30-113D-0010	30-123D-0010	30-213D-0010	30-223D-0010
U 3/Hk Barbosa Type	.56	0°	13°	—	—	30-213D-0014	30-223D-0014
U 4-5	.56	-7°	0°	30-1540-0010	30-1540-0010	30-2540-0010	30-2540-0010
U 4-5/Hk	.56	-7°	0°	30-114M-0010	30-124M-0010	30-214M-0010	30-224M-0010

MANDIBULAR

L 1-2	1.19	-1°	0°	30-1610-0010	30-1610-0010	30-2610-0010	30-2610-0010
L 3/Hk	.43	-11°	7°	30-143D-0010	30-133D-0010	30-243D-0010	30-233D-0010
L 3/Hk Barbosa Type	.43	-11°	7°	30-143D-0014	30-133D-0014	30-243D-0014	30-233D-0014
L 4 Offset base	.40	-17°	0°	30-1640-0013	30-1640-0013	30-2640-0013	30-2640-0013
L 4/Hk Offset base	.40	-17°	0°	30-144D-0010	30-134D-0010	30-244D-0010	30-234D-0010
L 5 Offset base	.38	-22°	0°	30-1650-0013	30-1650-0013	30-2650-0013	30-2650-0013
L 5/Hk Offset base	.38	-22°	0°	30-145D-0010	30-135D-0010	30-245D-0010	30-235D-0010

AXCESS Type Roth Kits

Prescription	Upper	Lower	Hook on	P/N	
				.018"	.022"
Roth Type	5-5	5-5	3	30-1CC3-0010	30-2CC3-0010
Roth Type	5-5	5-5	3,4,5	30-1CC5-0010	30-2CC5-0010

AXCESS bracket



AXCESS Type MBT*

MAXILLARY

Tooth	I/O mm	Torque	Angulation	.022"	
				R	L
U 1	.73	17°	4°	30-2110-0020	30-2210-0020
U 2	1.19	10°	8°	30-2120-0020	30-2220-0020
U 3	.56	-7°	8°	30-2130-0020	30-2230-0020
U 3/Hk	.56	-7°	8°	30-213D-0020	30-223D-0020
U 4/Hk	.56	-7°	0°	30-214D-0020	30-224D-0020
U 5 (Optionnal)	.67	-7°	0°	30-2550-0020	30-2550-0020
U 5/Hk (Optionnal)	.67	-7°	0°	30-215D-0020	30-225D-0020
U 4-5	.56	-7°	0°	30-2540-0020	30-2540-0020

MANDIBULAR

L 1-2	1.19	-6°	0°	30-2610-0020	30-2610-0020
L 3	.43	-6°	3°	30-2430-0020	30-2330-0020
L 3/Hk	.43	-6°	3°	30-243D-0020	30-233D-0020
L 4	.40	-12°	2°	30-2440-0020	30-2340-0020
L 4/Hk	.40	-12°	2°	30-244D-0020	30-234D-0020
L 5	.38	-17°	2°	30-2450-0020	30-2350-0020
L 5/Hk	.38	-17°	2°	30-245D-0020	30-2345D-0020

Kits AXCESS Type MBT*

Prescription	Upper	Lower	Hook on	.022"
MBT Type	5-5	5-5	3	30-2CC3-0020
MBT Type	5-5	5-5	3,4,5	30-2CC5-0020



EXPERIENCE mini metal Type Roth*



EXPERIENCE mini metal Type Roth MAXILLARY

Tooth	Torque	Angulation	Rotation	P/N			
				.018"		.022"	
				R	L	R	L
U 1	12°	5°	0°	21-1110-0010	21-1210-0010	21-2110-0010	21-2210-0010
U 2	8°	9°	0°	21-1120-0010	21-1220-0010	21-2120-0010	21-2220-0010
U 2/Hk	8°	9°	0°	21-112D-0010	21-122D-0010	21-212D-0010	21-222D-0010
U 3	-2°	13°	4°m	21-1130-0010	21-1230-0010	21-2130-0010	21-2230-0010
U 3/Hk	-2°	13°	4°m	21-113D-0010	21-123D-0010	21-213D-0010	21-223D-0010
U 3/(Optional)	-2°	10°	4°m	21-113D-0012	21-123D-0012	21-213D-0012	21-223D-0012
U 3/Passive	-2°	10°	4°m	—	—	21-4130-0010	21-4230-0010
U 3/Hk Passive	-2°	10°	4°m	—	—	21-413D-0010	21-423D-0010
U 4-5	-7°	0°	2°d	21-1140-0010	21-1240-0010	21-2140-0010	21-2240-0010
U 4-5/Hk	-7°	0°	2°d	21-114D-0010	21-124D-0010	21-214D-0010	21-224D-0010
U 4-5 Passive	-7°	0°	2°d	—	—	21-4140-0010	21-4240-0010
U 4-5/Hk Passive	-7°	0°	2°d	—	—	21-414D-0010	21-424D-0010

* Roth is a registered trademark of Roth Licensing LLC.

MANDIBULAR

Tooth	Torque	Angulation	Rotation	P/N			
				.018"		.022"	
				R	L	R	L
L 1-2	-1°	2°	0°	21-1410-0010	21-1310-0010	21-2410-0010	21-2310-0010
L 1-2/Hk	-1°	2°	0°	—	—	21-232D-0010	21-242D-0010
L 3	-11°	7°	2°m	21-1430-0010	21-1330-0010	21-2430-0010	21-2330-0010
L 3/Hk	-11°	7°	2°m	21-143D-0010	21-133D-0010	21-243D-0010	21-233D-0010
L 3/Passive	-11°	7°	2°m	—	—	21-4430-0010	21-4330-0010
L 3/Hk Passive	-11°	7°	2°m	—	—	21-443D-0010	21-433D-0010
L 4	-17°	-1°	4°d	21-1440-0010	21-1340-0010	21-2440-0010	21-2340-0010
L 4/Hk	-17°	-1°	4°d	21-144D-0010	21-134D-0010	21-244D-0010	21-234D-0010
L 4/Passive	-17°	-1°	4°d	—	—	21-4440-0010	21-4340-0010
L 4/Hk Passive	-17°	-1°	4°d	—	—	21-444D-0010	21-434D-0010
L 5	-22°	-1°	4°d	21-1450-0010	21-1350-0010	21-2450-0010	21-2350-0010
L 5/Hk	-22°	-1°	4°d	21-145D-0010	21-135D-0010	21-245D-0010	21-235D-0010
L 5 Passive	-22°	-1°	4°d	—	—	21-4450-0010	21-4350-0010
L 5/Hk Passive	-22°	-1°	4°d	—	—	21-445D-0010	21-435D-0010

Metalen brackets zijn verpakt per 10 stuks / Les brackets métalliques sont emballés par 10 pcs



EXPERIENCE mini metal Type MBT*



EXPERIENCE mini metal Type MBT MAXILLARY

Tooth	I/O mm	Torque	Angulation	P/N .018"	
				Interactive	
				R	L
U 1	0.74	17°	4°	21-1110-0020	21-1210-0020
U 2	1.06	10°	8°	21-1120-0020	21-1220-0020
U 3/Hk	0.55	-7°	8°	21-113D-0020	21-123D-0020
U 3/(Optional)	0.55	0°	8°	21-113D-0021	21-123D-0021
U 4-5	0.70	-7°	0°	21-1540-0020	21-1540-0020
U 4-5/Hk	0.70	-7°	0°	21-114D-0020	21-124D-0020
U 5/(Optional)	0.90	-7°	0°	21-1550-0020	21-1550-0020
U 5/Hk/(Optional)	0.90	-7°	0°	21-115D-0020	21-125D-0020

MANDIBULAR

Tooth	I/O mm	Torque	Angulation	P/N .018"	
				Interactive	
				R	L
L 1-2	1.05	-6	0	21-1610-0020	21-1610-0020
L 3/Hk	0.55	-6	3	21-143D-0020	21-133D-0020
L 3/(Optional)	0.55	0	3	21-143D-0021	21-133D-0021
L 4	0.55	-12	2	21-1440-0020	21-1340-0020
L 4/Hk	0.55	-12	2	21-144D-0020	21-134D-0020
L 5	0.55	-17	2	21-1450-0020	21-1350-0020
L 5/Hk	0.55	-17	2	21-145D-0020	21-135D-0020

*MBT is a trademark of 3M Unitek. All rights reserved.

Metalen brackets zijn verpakt per 10 stuks / Les brackets métalliques sont emballés par 10 pcs



50-0032-0000
For Experience Mini metal/rhodium

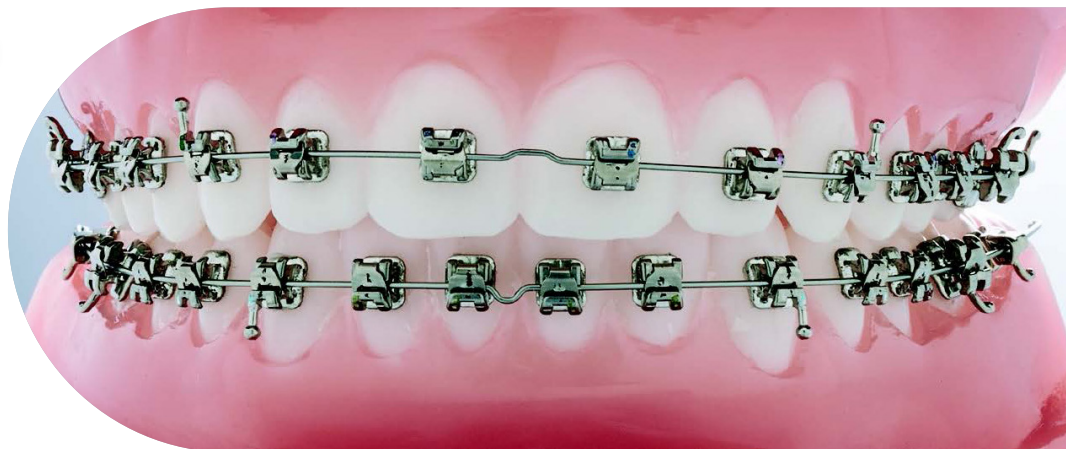



EXPERIENCE mini metal Type MBT*



EXPERIENCE mini metal Type MBT* MAXILLARY

Tooth	I/O mm	Torque	Angulation	P/N .022"			
				Interactive		Passive	
				R	L	R	L
U 1	0.74	17°	4°	21-2110-0020	21-2210-0020	21-4110-0020	21-4210-0020
U 2	1.06	10°	8°	21-2120-0020	21-2220-0020	21-4120-0020	21-4220-0020
U 3	0.55	-7°	8°	21-2130-0020	21-2230-0020	21-4130-0020	21-4230-0020
U 3/Hk	0.55	-7°	8°	21-213D-0020	21-223D-0020	21-413D-0020	21-423D-0020
U 3/(Optional)	0.55	0°	8°	21-213D-0021	21-223D-0021	—	—
U 4-5	0.70	-7°	0°	21-2540-0020	21-2540-0020	21-4540-0020	21-4540-0020
U 4-5/Hk	0.70	-7°	0°	21-214D-0020	21-224D-0020	21-414D-0020	21-424D-0020
U 5/(Optional)	0.90	-7°	0°	21-2550-0020	21-2550-0020	21-4550-0020	21-4550-0020
U 5/Hk/(Optional)	0.90	-7°	0°	21-215D-0020	21-225D-0020	21-415D-0020	21-425D-0020

MANDIBULAR

Tooth	I/O mm	Torque	Angulation	P/N .022"			
				Interactive		Passive	
				R	L	R	L
L 1-2	1.05	-6	0	21-2610-0020	21-2610-0020	21-4610-0020	21-4610-0020
L 3	0.55	-6	3	21-2430-0020	21-2330-0020	21-4430-0020	21-4330-0020
L 3/(Optional)	0.55	0	3	21-243D-0021	21-233D-0021	—	—
L 3/Hk	0.55	-6	3	21-243D-0020	21-233D-0020	21-443D-0020	21-433D-0020
L 4	0.55	-12	2	21-2440-0020	21-2340-0020	21-4440-0020	21-4340-0020
L 4/Hk	0.55	-12	2	21-244D-0020	21-234D-0020	21-444D-0020	21-434D-0020
L 5	0.55	-17	2	21-2450-0020	21-2350-0020	21-4450-0020	21-4350-0020
L 5/Hk	0.55	-17	2	21-245D-0020	21-235D-0020	21-445D-0020	21-435D-0020

Metalen brackets zijn verpakt per 10 stuks / Les brackets métalliques sont emballés par 10 pcs

EXPERIENCE mini metal Kits

EXPERIENCE mini metal Kits

Prescription	Upper arch	Lower arch	Hook on	P/N	
				.018"	.022"
Type Roth/Interactive	5-5	5-5	—	21-1CC0-0010	21-2CC0-0010
Type Roth/Interactive	5-5	5-5	3	21-1CC3-0010	21-2CC3-0010
Type Roth/Interactive	5-5	5-5	3,4,5	21-1CC5-0010	21-2CC5-0010
Type MBT*/Interactive	5-5	5-5	3	21-1CC3-0020	21-2CC3-0020
Type MBT*/Interactive	5-5	5-5	3,4,5	21-1CC5-0020	21-2CC5-0020
Type MBT*/Passive	5-5	5-5	3	—	21-4CC3-0020
Type MBT*/Passive	5-5	5-5	3,4,5	—	21-4CC5-0020



EXPERIENCE mini metal



EXPERIENCE mini metal GET



MAXILLARY

Tooth	Torque	Angulation	Rotation	P/N	
				R	L
U 1 .020" x .028"	12°	5°	0°	21-5110-0500	21-5210-0500
U 2 .020" x .028"	8°	9°	0°	21-5120-0500	21-5220-0500
U 3/Hk .022" x .028"	0°	11°	0°	21-213D-0500	21-223D-0500
U 4/5 .022" x .028"	-10°	4°	2°d	21-2140-0500	21-2240-0500
U 4/5/Hk .022" x .028"	-10°	4°	2°d	21-214M-0500	21-224M-0500

MANDIBULAR

Tooth	Torque	Angulation	Rotation	P/N	
				R	L
L 1/2 .020" x .028"	-1°	2°	0°	21-5410-0500	21-5310-0500
L 3/Hk .022" x .028"	-3°	3°	0°	21-243D-0500	21-233D-0500
L 4 .022" x .028"	-17°	1°	4°d	21-2440-0500	21-2340-0500
L 4/Hk .022" x .028"	-17°	1°	4°d	21-244D-0500	21-234D-0500
L 5 .022" x .028"	-22°	1°	4°d	21-2450-0500	21-2350-0500
L 5/Hk .022" x .028"	-22°	1°	4°d	21-245D-0500	21-235D-0500

EXPERIENCE mini metal Extra Torque

MAXILLARY

Tooth	Torque	Angulation	Rotation	P/N			
				.018"		.022"	
				R	L	R	L
U 1	18°	5°	0°	21-1110-0030	21-1210-0030	21-2110-0030	21-2210-0030
U 2	10°	8°	0°	21-1120-0030	21-1220-0030	21-2120-0030	21-2220-0030
U 2/Hk	10°	8°	0°	21-112D-0030	21-122D-0030	21-212D-0030	21-222D-0030
U 3	0°	8°	2°m	21-1130-0030	21-1230-0030	21-2130-0030	21-2230-0030
U 3/Hk	0°	8°	2°m	21-113D-0030	21-123D-0030	21-213D-0030	21-223D-0030
U 4-5	-10°	4°	2°d	21-1140-0030	21-1240-0030	21-2140-0030	21-2240-0030
U 4-5/Hk	-10°	4°	2°d	21-114M-0030	21-124M-0030	21-214M-0030	21-224M-0030

MANDIBULAR

Tooth	Torque	Angulation	Rotation	P/N			
				.018"		.022"	
				R	L	R	L
L 1-2	1°	0°	0°	21-1610-0030	21-1610-0030	21-2610-0030	21-2610-0030
L 3	-3°	7°	2°m	21-1430-0030	21-1330-0030	21-2430-0030	21-2330-0030
L 3/Hk	-3°	7°	2°m	21-143D-0030	21-133D-0030	21-243D-0030	21-233D-0030
L4/(Optional)	0°	0°	0°	21-1540-0025	21-1540-0025	21-2540-0025	21-2540-0025
L 4/5	-7°	-1°	2°d	21-1440-0030	21-1340-0030	21-2440-0030	21-2340-0030
L 4/5/Hk	-7°	-1°	2°d	21-144D-0030	21-134D-0030	21-244D-0030	21-234D-0030

Metalen brackets zijn verpakt per 10 stuks / Les brackets métalliques sont emballés par 10 pcs



EXPERIENCE metal

Type Roth*



EXPERIENCE metal Type Roth MAXILLARY

Tooth	I/O mm	Torque	Angulation	Rotation	P/N			
					.018"		.022"	
					R	L	R	L
U 1	.81	12°	5°	0°	20-1110-0010	20-1210-0010	20-2110-0010	20-2210-0010
U 2	1.07	8°	9°	0°	20-1120-0010	20-1220-0010	20-2120-0010	20-2220-0010
U 2/Hk	1.07	8°	9°	0°	20-112D-0010	20-122D-0010	20-212D-0010	20-222D-0010
U 3	.46	-2°	13°	4°m	20-1130-0010	20-1230-0010	20-2130-0010	20-2230-0010
U 3/(Optional)	.46	-2°	10°	4°m	—	—	20-2130-0012	20-2230-0012
U 3/Hk	.46	-2°	13°	4°m	20-113D-0010	20-123D-0010	20-213D-0010	20-223D-0010
U 3/Hk	.46	-2°	10°	4°m	20-113D-0012	20-123D-0012	20-213D-0012	20-223D-0012
U 4-5	.46	-7°	0°	2°d	20-1140-0010	20-1240-0010	20-2140-0010	20-2240-0010
U 4-5/Hk d.	.46	-7°	0°	2°d	20-114D-0010	20-124D-0010	20-214D-0010	20-224D-0010
U 4-5/Hk m.	.46	-7°	0°	2°d	20-114M-0010	20-124M-0010	20-214M-0010	20-224M-0010

MANDIBULAR

Tooth	I/O mm	Torque	Angulation	Rotation	P/N			
					.018"		.022"	
					R	L	R	L
L 1-2	1.17	-1°	2°	0° 2	0-1410-0010	20-1310-0010	20-2410-0010	20-2310-0010
L 2/Hk	1.17	-1°	2°	0°	—	—	20-242D-0010	20-232D-0010
L 3	.56	-11°	7°	2°m	20-1430-0010	20-1330-0010	20-2430-0010	20-2330-0010
L 3/Hk	.56	-11°	7°	2°m	20-143D-0010	20-133D-0010	20-243D-0010	20-233D-0010
L 4	.38	-17°	-1°	4°d	20-1440-0010	20-1340-0010	20-2440-0010	20-2340-0010
L 4/(Offset Base)	.38	-17°	-1°	4°d	20-1440-0013	20-1340-0013	20-2440-0013	20-2340-0013
L 4/Hk	.38	-17°	-1°	4°d	20-144D-0010	20-134D-0010	20-244D-0010	20-234D-0010
L 4/Hk/(Off. Base)	.38	-17°	-1°	4°d	—	—	20-244D-0013	20-234D-0013
L 5	.28	-22°	-1°	4°d	20-1450-0010	20-1350-0010	20-2450-0010	20-2350-0010
L 5/(Offset Base)	.28	-22°	-1°	4°d	20-1450-0013	20-1350-0013	20-2450-0013	20-2350-0013
L 5/Hk	.28	-22°	-1°	4°d	20-145D-0010	20-135D-0010	20-245D-0010	20-235D-0010
L 5/Hk/(Off. Base)	.28	-22°	-1°	4°d	—	—	20-245D-0013	20-235D-0013

Metalen brackets zijn verpakt per 10 stuks /
Les brackets métalliques sont emballés par 10 pcs





EXPERIENCE metal

Type Roth*



EXPERIENCE metal Type Roth .020"x .028"

This bracket features an original slot size on upper and lower incisors: .020"x .028". In conjunction with .020"x .025" stainless steel archwires, the system controls the anterior torque and provides increased rigidity to the buccal segments during space closure.

MAXILLARY

Tooth	I/O mm	Torque	Angulation	Rotation	P/N	
					R	L
U 1 .020"x .028"	.81	12°	5°	0°	20-5110-0010	20-5210-0010
U 2 .020"x .028"	1.07	8°	9°	0°	20-5120-0010	20-5220-0010
U 3 Hk .022"x .028"	.46	0°	8°	2°m	20-213D-0030	20-223D-0030
U 4/5 .022"x .028"	.46	-7°	0°	2°d	20-2140-0010	20-2240-0010
U 4/5 Hk .022"x .028"	.46	-7°	0°	2°d	20-214D-0010	20-224D-0010

MANDIBULAR

Tooth	I/O mm	Torque	Angulation	Rotation	P/N	
					R	L
L 1/2 .020"x .028"	1.17	-1°	2°	0°	20-5410-0010 2	0-5310-0010
L 3 Hk .022"x .028"	.56	-3°	7°	2°m	20-243D-0030	20-233D-0030
L 4 Hk .022"x .028"	.38	-17°	-1°	4°d	20-244D-0010	20-234D-0010
L 5 Hk .022"x .028"	.28	-22°	-1°	4°d	20-245D-0010	20-235D-0010

Metalen brackets zijn verpakt per 10 stuks / Les brackets métalliques sont emballés par 10 pcs

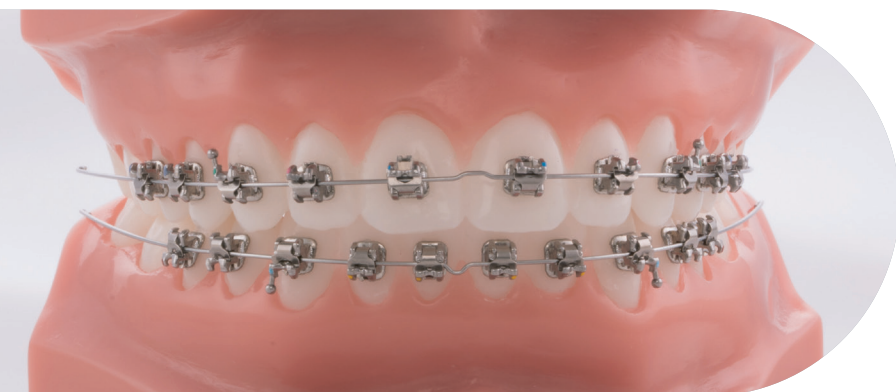



EXPERIENCE metal

Extra Torque



EXPERIENCE metal Extra Torque

This prescription is based on the use of less than full size archwires due to increased torque on the maxillary incisors. Increased buccal root torque in the upper bicuspids prevents any lingual cusp interference.

MAXILLARY

Tooth	I/O mm	Torque	Angulation	Rotation	P/N			
					.018"		.022"	
					R	L	R	L
U 1	.81	18°	5°	0°	20-1110-0030	20-1210-0030	20-2110-0030	20-2210-0030
U 2	1.07	10°	8°	0°	20-1120-0030	20-1220-0030	20-2120-0030	20-2220-0030
U 2/Hk	1.07	10°	8°	0°	20-112D-0030	20-122D-0030	20-212D-0030	20-222D-0030
U 3	.46	0°	8°	2°m	20-1130-0030	20-1230-0030	20-2130-0030	20-2230-0030
U 3/Hk	.46	0°	8°	2°m	20-113D-0030	20-123D-0030	20-213D-0030	20-223D-0030
U 4-5	.46	-10°	4°	2°d	20-1140-0030	20-1240-0030	20-2140-0030	20-2240-0030
U 4-5/Hk	.46	-10°	4°	2°d	20-114M-0030	20-124M-0030	20-214M-0030	20-224M-0030

MANDIBULAR

Tooth	I/O mm	Torque	Angulation	Rotation	P/N			
					.018"		.022"	
					R	L	R	L
L 1-2	1.17	1°	0°	0°	20-1610-0030	20-1610-0030	20-2610-0030	20-2610-0030
L 3	.56	-3°	7°	2°m	20-1430-0030	20-1330-0030	20-2430-0030	20-2330-0030
L 3/Hk	.56	-3°	7°	2°m	20-143D-0030	20-133D-0030	20-243D-0030	20-233D-0030
L 4/5	.33	-7°	-1°	2°d	20-1440-0030	20-1340-0030	20-2440-0030	20-2340-0030
L 4/5/Hk	.33	-7°	-1°	2°d	20-144D-0030	20-134D-0030	20-244D-0030	20-234D-0030

Metalen brackets zijn verpakt per 10 stuks /
Les brackets métalliques sont emballés par 10 pcs





EXPERIENCE metal

Type MBT*



EXPERIENCE metal Type MBT*

MAXILLARY

Tooth	I/O mm	Torque	Angulation	Rotation	P/N			
					.018"		.022"	
					R	L	R	L
U 1	.81	17°	4°	0°	20-1110-0020	20-1210-0020	20-2110-0020	20-2210-0020
U 2 1	.07	10°	8°	0°	20-1120-0020	20-1220-0020	20-2120-0020	20-2220-0020
U 3	.46	-7°	8°	0°	20-1130-0020	20-1230-0020	20-2130-0020	20-2230-0020
U 3/Hk	.46	-7°	8°	0°	20-113D-0020	20-123D-0020	20-213D-0020	20-223D-0020
U 3/Hk	.46	0°	8°	0°	20-113D-0021	20-123D-0021	20-213D-0021	20-223D-0021
U 4-5	.46	-7°	0°	0°	20-1540-0020	20-1540-0020	20-2540-0020	20-2540-0020
U 4-5/Hk	.46	-7°	0°	0°	20-114D-0020	20-124D-0020	20-214D-0020	20-224D-0020
U 5/(Optional)	.96	-7°	0°	0°	20-1540-0020X	20-1540-0020X	20-2550-0020	20-2550-0020
U 5/Hk/(Opt)	.96	-7°	0°	0°	20-115D-0020	20-125D-0020	20-215D-0020	20-225D-0020

MANDIBULAR

Tooth	I/O mm	Torque	Angulation	Rotation	P/N			
					.018"		.022"	
					R	L	R	L
L 1-2	1.17	-6°	0°	0°	20-1610-0020	20-1610-0020	20-2610-0020	20-2610-0020
L 3	.56	-6°	3°	0°	20-1430-0020	20-1330-0020	20-2430-0020	20-2330-0020
L 3/Hk	.56	-6°	3°	0°	20-143D-0020	20-133D-0020	20-243D-0020	20-233D-0020
L 3/Hk	.56	0°	3°	0°	20-143D-0021	20-133D-0021	20-243D-0021	20-233D-0021
L 4	.33	-12°	2°	0°	20-1440-0020	20-1340-0020	20-2440-0020	20-2340-0020
L 4/Hk	.33	-12°	2°	0°	20-144D-0020	20-134D-0020	20-244D-0020	20-234D-0020
L 5	.33	-17°	2°	0°	20-1450-0020	20-1350-0020	20-2450-0020	20-2350-0020
L 5/Hk	.33	-17°	2°	0°	20-145D-0020	20-135D-0020	20-245D-0020	20-235D-0020

Metalen brackets zijn verpakt per 10 stuks /
Les brackets métalliques sont emballés par 10 pcs





EXPERIENCE metal

Type Andrews*



EXPERIENCE metal Type Andrews MAXILLARY

Tooth	I/O mm	Torque	Angulation	Rotation	P/N	
					.022"	
					R	L
U 1	.81	7°	5°	0°	20-2110-0044	20-2210-0044
U 2	1.07	3°	9°	0°	20-2120-0044	20-2220-0044
U 3/Hk	.46	-7°	11°	0°	20-213D-0044	20-223D-0044
U 4/5	.46	-7°	0°	0°	20-2540-0044	20-2540-0044

MANDIBULAR

Tooth	I/O mm	Torque	Angulation	Rotation	P/N	
					.022"	
					R	L
L 1/2	1.17	-6°	2°	0°	20-2410-0044	20-2310-0044
L 1/2	1.17	-1°	0°	0°	20-2610-0044	20-2610-0044
L 3/Hk	.56	-11°	5°	0°	20-243D-0044	20-233D-0044
L 4	.38	-17°	0°	0°	20-2640-0044	20-2640-0044
L 5	.28	-22°	0°	0°	20-2650-0044	20-2650-0044

Metalen brackets zijn verpakt per 10 stuks / Les brackets métalliques sont emballés par 10 pcs

EXPERIENCE metal Optional

EXPERIENCE metal Optional MAXILLARY

Tooth	I/O mm	Torque	Angulation	Rotation	P/N			
					.018"		.022"	
					R	L	R	L
U 1	.81	24°	5°	0°	—	—	20-2110-0017	20-2210-0017
U 2	1.07	16°	8°	0°	—	—	20-2120-0017	20-2220-0017
U 3/Hk	.46	7°	5°	0°	20-113D-0027	20-123D-0027	20-213D-0027	20-223D-0027
U 4	.46	0°	0°	0°	20-1540-0025	20-1540-0025	20-2540-0025	20-2540-0025

Metalen brackets zijn verpakt per 10 stuks / Les brackets métalliques sont emballés par 10 pcs

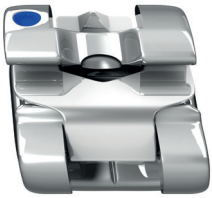

EXPERIENCE metal Kits



EXPERIENCE metal Kits

EXPERIENCE metal .020" x .028" Kit	Upper arch	Lower arch	With Hook	P/N
Type Roth .020" x .028"	5-5	5-5	3,4,5	.020" x .028" 20-5CC5-0010

Prescription	Upper arch	Lower arch	With Hook	P/N	
				.018"	.022"
Type Roth	5-5	5-5	—	20-1CC0-0010	20-2CC0-0010
Type Roth	5-5	5-5	3	20-1CC3-0010	20-2CC3-0010
Type Roth	5-5	5-5	3,4,5	20-1CC5-0010	20-2CC5-0010

Prescription	Upper arch	Lower arch	With Hook	P/N	
				.018"	.022"
Extra Torque	5-5	5-5	—	20-1CC0-0030	20-2CC0-0030
Extra Torque	5-5	5-5	3	20-1CC3-0030	20-2CC3-0030
Extra Torque	5-5	5-5	3,4,5	20-1CC5-0030	20-2CC5-0030

Prescription	Upper arch	Lower arch	With Hook	P/N	
				.018"	.022"
Type MBT*	5-5	5-5	—	20-1CC0-0020	20-2CC0-0020
Type MBT*	5-5	5-5	3	20-1CC3-0020	20-2CC3-0020
Type MBT*	5-5	5-5	3,4,5	20-1CC5-0020	20-2CC5-0020

Prescription	Upper arch	Lower arch	With Hook	P/N	
				.018"	.022"
Andrews Type	5-5	5-5	3	—	20-2CC3-0044
ACO	5-5	5-5	3	—	20-2CC3-0007
ACO	5-5	5-5	3,4,5	—	20-2CC5-0007

Instruments for working with EXPERIENCE brackets:

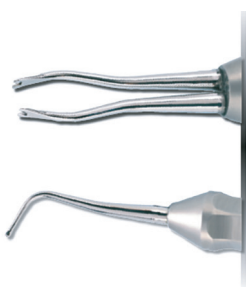

M-tool features both a double forked end to facilitate wire insertion and an end with a hollow ball to safely open the bracket from the gingival edge
P/N. 50-2030-0000



Open tool is for opening EXPERIENCE brackets either from the buccal face (hook side) or from the gingival edge (safety) using the hollow sphere.
P/N. 50-0030-0000

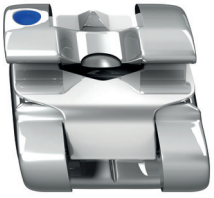

EXPERIENCE metal

ACO

EXPERIENCE CERAMIC ACO

MAXILLARY

Tooth	Torque	Angulation	Rotation	P/N	
				.022" x.028"	
				R	L
U 1	12°	5°	0°	20-2110-0007	20-2210-0007
U 2	10°	9°	0°	20-2120-0007	20-2220-0007
U 3/Hk	-7°	10°	2m	20-213D-0007	20-223D-0007
U 4-5	-9°	0°	0°	20-2540-0007	20-2540-0007
U 4-5/Hk	-9°	0°	0°	20-214D-0007	20-224D-0007

MANDIBULAR

Tooth	Torque	Angulation	Rotation	P/N	
				.022" x.028"	
				R	L
L 1/2	-6°	0°	0°	20-2610-0007	20-2610-0007
L 3/Hk	-8°	3°	0°	20-243D-0007	20-233D-0007
L 4	-12°	2°	0°	20-2440-0007	20-2340-0007
L 4/Hk	-12°	2°	0°	20-244D-0007	20-234D-0007
L 5	-17°	-1°	0°	20-2450-0007	20-2350-0007
L 5/Hk	-17°	-1°	0°	20-245D-0007	20-235D-0007



EXPERIENCE L



EXPERIENCE L MAXILLARY

Tooth	Torque	Angulation	Rotation	P/N	
				.018"	
				R	L
U 1-2	60°	0°	0°	16-1510-0010	16-1510-0010
U 3	60°	0°	0°	16-1530-0010	16-1530-0010
U 3/Hk	60°	0°	0°	16-153U-0010	16-153U-0010
U 4-5	10°	0°	0°	16-1740-0010	16-1740-0010
U 4-5/Hk	10°	0°	0°	16-174U-0010	16-174U-0010
U 6-7/Hk	10°	0°	0°	16-116M-0010	16-126M-0010
U 7/Comfortube	0°	0°	0°	40-1770-0000	40-1770-0000

MANDIBULAR

Tooth	Torque	Angulation	Rotation	P/N	
				.018"	
				R	L
L 1-2	50°	0°	0°	16-1610-0010	16-1610-0010
L 3	50°	0°	0°	16-1630-0010	16-1630-0010
L 3/Hk	50°	0°	0°	16-163U-0010	16-163U-0010
L 4-5	10°	0°	0°	16-1740-0010	16-1740-0010
L 4-5/Hk	10°	0°	0°	16-174U-0010	16-174U-0010
L 6-7/Hk	0°	0°	0°	16-146M-0010	16-136M-0010
L 7/Comfortube	0°	0°	0°	40-1770-0000	40-1770-0000

Deze brackets zijn verpakt per 5 stuks / Ces brackets sont emballés par 5 pcs

EXPERIENCE L Kits (Brackets Only)

	P/N
	.018"
U 7-7	16-1A00-0010
U/L 7-7	16-1AA0-0010



EXPERIENCE LSB



EXPERIENCE LSB MAXILLARY

Tooth	Torque	Angulation	Rotation	P/N	
				.018"	
				R	L
U 1-2-3	60°	0°	0°	17-1510-0010	17-1510-0010
U 3/Hk	60°	0°	0°	17-153U-0010	17-153U-0010

MANDIBULAR

Tooth	Torque	Angulation	Rotation	P/N	
				.018"	
				R	L
L 1-2-3	50°	0°	0°	17-1610-0010	17-1610-0010
L 1-2-3/Narrow Base	50°	0°	0°	17-1610-0050	17-1610-0050
L 3/Hk	50°	0°	0°	17-163U-0010	17-163U-0010

Deze brackets zijn verpakt per 5 stuks /Ces brackets sont emballés par 5 pcs

EXPERIENCE LSB Kits (Brackets Only)

	P/N
	.018"
EXPERIENCE LSB U 3-3 Kit	17-1E00-0010
EXPERIENCE LSB L 3-3 Kit	17-10E0-0010
EXPERIENCE LSB U/L 3-3 Kit	17-1EE0-0010





miniPrevail®Twin

PRECISION MANUFACTURED BY G&H® ORTHODONTICS

miniPrevail®TWIN Brackets MAXILLARY ROTH' Rx

Tooth	Torque	Angle	Rotation	M/D	R/L	ID	Mesh Base		Offset Bicuspid Mesh Base Option	
							.018	.022	.018	.022
Central	12°	5°	0°	.140"	R	●	36-U1-8R	36-U1-2R	-	-
					L	●	36-U1-8L	36-U1-2L	-	-
Central Hi-Torque	22°	5°	0°	.140"	R	●	39-U1-8R	39-U1-2R	-	-
					L	●	39-U1-8L	39-U1-2L	-	-
Lateral	8°	9°	0°	.115"	R	○	36-U2-8R	36-U2-2R	-	-
					L	○	36-U2-8L	36-U2-2L	-	-
Lateral Hi-Torque	14°	9°	0°	.115"	R	○	39-U2-8R	39-U2-2R	-	-
					L	○	39-U2-8L	39-U2-2L	-	-
Cuspid (-Hook)	0°	11°	0°	.122"	R	●	36-U3-8R	36-U3-2R	-	-
					L	●	36-U3-8L	36-U3-2L	-	-
Cuspid Hk (+Hook)	0°	11°	0°	.122"	R	●	36-U3-8RK	36-U3-2RK	-	-
					L	●	36-U3-8LK	36-U3-2LK	-	-
Bicuspid	-7°	0°	0°	.122"	U	●●	36-U4-8U	36-U4-2U	36-U4-8UO	36-U4-2UO
Bicuspid Hk	-7°	0°	0°	.122"	R	●	36-U4-8RK	36-U4-2RK	36-U4-8RKO	36-U4-2RKO
					L	●	36-U4-8LK	36-U4-2LK	36-U4-8LKO	36-U4-2LKO

MANDIBULAR ROTH' Rx

Tooth	Torque	Angle	Rotation	M/D	R/L	ID	Mesh Base		Offset Bicuspid Mesh Base Option	
							.018	.022	.018	.022
Anterior	0°	0°	0°	.100"	U	●●	36-L1-8U	36-L1-2U	-	-
Cuspid (-Hook)	-11°	5°	0°	.122"	R	●	36-L3-8R	36-L3-2R	-	-
					L	●	36-L3-8L	36-L3-2L	-	-
Cuspid Hk (+ Hook)	-11°	5°	0°	.122"	R	●	36-L3-8RK	36-L3-2RK	-	-
					L	●	36-L3-8LK	36-L3-2LK	-	-
1 st Bicuspid	-17°	0°	0°	.122"	U	●●	36-L4-8U	36-L4-2U	36-L4-8UO	36-L4-2UO
1 st Bicuspid Hk	-17°	0°	0°	.122"	R	●	36-L4-8RK	36-L4-2RK	36-L4-8RKO	36-L4-2RKO
					L	●	36-L4-8LK	36-L4-2LK	36-L4-8LKO	36-L4-2LKO
2 nd Bicuspid	-22°	0°	0°	.122"	U	●●	36-L5-8U	36-L5-2U	36-L5-8UO	36-L5-2UO
2 nd Bicuspid Hk	-22°	0°	0°	.122"	R	●	36-L5-8RK	36-L5-2RK	36-L5-8RKO	36-L5-2RKO
					L	●	36-L5-8LK	36-L5-2LK	36-L5-8LKO	36-L5-2LKO

Metalen brackets zijn verpakt per 10 stuks / Les brackets métalliques sont emballés par 10 pcs

Bracket Kits ROTH' Rx

20 brackets per kit	Mesh Base		Offset Bicuspid Mesh Base Option	
	.018	.022	.018	.022
Upper/Lower 5x5 Hook on 3	36K-3-18-01	36K-3-22-01	36KO-3-18-01	36KO-3-22-01
Upper/Lower 5x5 Hook on 3, 4, & 5	36K-345-18-01	36K-345-22-01	36KO-345-18-01	36KO-345-22-01

Brackets are packaged with 1 case oriented in a kit box.



miniPrevail®Twin

PRECISION MANUFACTURED BY G&H® ORTHODONTICS

miniPrevail®TWIN Brackets Vertical slot measures .018x.018 MAXILLARY ROTH' Rx V-Slot

Tooth	Torque	Angle	Rotation	M/D	R/L	ID	Mesh Base		Offset Bicuspid Mesh Base Option	
							.018	.022	.018	.022
Central	12°	5°	0°	.140"	R	●	38-U1-8R	38-U1-2R	-	-
					L	●	38-U1-8L	38-U1-2L	-	-
Lateral	8°	9°	0°	.115"	R	○	38-U2-8R	38-U2-2R	-	-
					L	○	38-U2-8L	38-U2-2L	-	-
Cuspid (-Hook)	0°	11°	0°	.122"	R	●	38-U3-8R	38-U3-2R	-	-
					L	●	38-U3-8L	38-U3-2L	-	-
Cuspid Hk (+Hook)	0°	11°	0°	.122"	R	●	38-U3-8RK	38-U3-2RK	-	-
					L	●	38-U3-8LK	38-U3-2LK	-	-
Bicuspid	-7°	0°	0°	.122"	U	●●	38-U4-8U	38-U4-2U	38-U4-8UO	38-U4-2UO
Bicuspid Hk	-7°	0°	0°	.122"	R	●	38-U4-8RK	38-U4-2RK	38-U4-8RKO	38-U4-2RKO
					L	●	38-U4-8LK	38-U4-2LK	38-U4-8LKO	38-U4-2LKO

MANDIBULAR ROTH' Rx V-Slot

Tooth	Torque	Angle	Rotation	M/D	R/L	ID	Mesh Base		Offset Bicuspid Mesh Base Option	
							.018	.022	.018	.022
Anterior	0°	0°	0°	.100"	U	●●	38-L1-8U	38-L1-2U	-	-
Cuspid (-Hook)	-11°	5°	0°	.122"	R	●	38-L3-8R	38-L3-2R	-	-
					L	●	38-L3-8L	38-L3-2L	-	-
Cuspid Hk (+Hook)	-11°	5°	0°	.122"	R	●	38-L3-8RK	38-L3-2RK	-	-
					L	●	38-L3-8LK	38-L3-2LK	-	-
1 st Bicuspid	-17°	0°	0°	.122"	U	●●	38-L4-8U	38-L4-2U	38-L4-8UO	38-L4-2UO
1 st Bicuspid Hk	-17°	0°	0°	.122"	R	●	38-L4-8RK	38-L4-2RK	38-L4-8RKO	38-L4-2RKO
					L	●	38-L4-8LK	38-L4-2LK	38-L4-8LKO	38-L4-2LKO
2 nd Bicuspid	-22°	0°	0°	.122"	U	●●	38-L5-8U	38-L5-2U	38-L5-8UO	38-L5-2UO
2 nd Bicuspid Hk	-22°	0°	0°	.122"	R	●	38-L5-8RK	38-L5-2RK	38-L5-8RKO	38-L5-2RKO
					L	●	38-L5-8LK	38-L5-2LK	38-L5-8LKO	38-L5-2LKO

Metalen brackets zijn verpakt per 10 stuks / Les brackets métalliques sont emballés par 10 pcs

Bracket Kits ROTH' Rx V-Slot

20 brackets per kit	Mesh Base		Offset Bicuspid Mesh Base Option	
	.018	.022	.018	.022
Upper/Lower 5x5 Hook on 3	38K-3-18-01	38K-3-22-01	38KO-3-18-01	38KO-3-22-01
Upper/Lower 5x5 Hook on 3, 4, & 5	38K-345-18-01	38K-345-22-01	38KO-345-18-01	38KO-345-22-01

Brackets are packaged with 1 case oriented in a kit box.



Metalen/Métalliques BRACKETS



miniPrevail®Twin

PRECISION MANUFACTURED BY G&H® ORTHODONTICS

miniPrevail®TWIN Brackets MAXILLARY MBT² Rx

Tooth	Torque	Angle	Rotation	M/D	R/L	ID	Mesh Base		Offset Bicuspid Mesh Base Option	
							.018	.022	.018	.022
Central	17°	4°	0°	.140"	R	●	37-U1-8R	37-U1-2R	-	-
					L	●	37-U1-8L	37-U1-2L	-	-
Lateral	10°	8°	0°	.115"	R	○	37-U2-8R	37-U2-2R	-	-
					L	○	37-U2-8L	37-U2-2L	-	-
Cuspid (-Hook)	-7°	8°	0°	.122"	R	●	37-U3-8R	37-U3-2R	-	-
					L	●	37-U3-8L	37-U3-2L	-	-
Cuspid Hk (+Hook)	-7°	8°	0°	.122"	R	●	37-U3-8RK	37-U3-2RK	-	-
					L	●	37-U3-8LK	37-U3-2LK	-	-
Cuspid (-Hook)	0°	8°	0°	.122"	R	●	37-U3-8R0	37-U3-2R0	-	-
					L	●	37-U3-8L0	37-U3-2L0	-	-
Cuspid Hk (+Hook)	0°	8°	0°	.122"	R	●	37-U3-8RK0	37-U3-2RK0	-	-
					L	●	37-U3-8LK0	37-U3-2LK0	-	-
Bicuspid	-7°	0°	0°	.122"	U	●●	37-U4-8U	37-U4-2U	37-U4-8UO	37-U4-2UO
Bicuspid Hk	-7°	0°	0°	.122"	R	●	37-U4-8RK	37-U4-2RK	37-U4-8RKO	37-U4-2RKO
					L	●	37-U4-8LK	37-U4-2LK	37-U4-8LKO	37-U4-2LKO

MANDIBULAR MBT² Rx

Tooth	Torque	Angle	Rotation	M/D	R/L	ID	Mesh Base		Offset Bicuspid Mesh Base Option	
							.018	.022	.018	.022
Anterior	-6°	0°	0°	.100"	U	●●	37-L1-8U	37-L1-2U	-	-
Cuspid (-Hook)	-6°	3°	0°	.122"	R	●	37-L3-8R	37-L3-2R	-	-
					L	●	37-L3-8L	37-L3-2L	-	-
Cuspid Hk (+Hook)	-6°	3°	0°	.122"	R	●	37-L3-8RK	37-L3-2RK	-	-
					L	●	37-L3-8LK	37-L3-2LK	-	-
Cuspid (-Hook)	0°	3°	0°	.122"	R	●	37-L3-8R0	37-L3-2R0	-	-
					L	●	37-L3-8L0	37-L3-2L0	-	-
Cuspid Hk (+Hook)	0°	3°	0°	.122"	R	●	37-L3-8RK0	37-L3-2RK0	-	-
					L	●	37-L3-8LK0	37-L3-2LK0	-	-
1st Bicuspid	-12°	0°	0°	.122"	U	●●	37-L4-8U	37-L4-2U	37-L4-8UO	37-L4-2UO
1st Bicuspid Hk	-12°	0°	0°	.122"	R	●	37-L4-8RK	37-L4-2RK	37-L4-8RKO	37-L4-2RKO
					L	●	37-L4-8LK	37-L4-2LK	37-L4-8LKO	37-L4-2LKO
2nd Bicuspid	-17°	0°	0°	.122"	U	●●	37-L5-8U	37-L5-2U	37-L5-8UO	37-L5-2UO
					2nd Bicuspid Hk	-17°	0°	0°	.122"	R
L	●	37-L5-8LK	37-L5-2LK	37-L5-8LKO						37-L5-2LKO

Metalen brackets zijn verpakt per 10 stuks / Les brackets métalliques sont emballés par 10 pcs

Bracket Kits MBT² Rx

20 brackets per kit	Mesh Base		Offset Bicuspid Mesh Base Option	
	.018	.022	.018	.022
Upper/Lower 5x5 Hook on 3	37K-3-18-01	37K-3-22-01	37KO-3-18-01	37KO-3-22-01
Upper/Lower 5x5 Hook on 3, 4, & 5	37K-345-18-01	37K-345-22-01	37KO-345-18-01	37KO-345-22-01

MBT Rx kits include 0° torque on the cuspids - custom kits available upon request.
Brackets are packaged with 1 case oriented in a kit box. Brackets are also available in kits of 5 or 10 cases oriented in a carousel dispenser. Brackets are also available as kits in bags



Evolve Bracket system

Type MBT*/Roth*

Evolve bracket system MAXILLARY ARCH

	MBT*.022				Roth*.022			
	Torq°	Angle°	Width (mm)	Code	Torq°	Angle°	Width (mm)	Code
Right Central	17	4	4.0	DB16-0100	12	5	4.0	DB16-0040
Left Central	17	4	4.0	DB16-0101	12	5	4.0	DB16-0041
Right Lateral	10	8	3.0	DB16-0102	8	9	3.0	DB16-0042
Left Lateral	10	8	3.0	DB16-0103	8	9	3.0	DB16-0043
Right Cuspid w/ Hook	-7	9	3.5	DB16-0104	0	11	3.5	DB16-0046
Left Cuspid w/ Hook	-7	9	3.5	DB16-0105	0	11	3.5	DB16-0047
Right Cuspid	-7	9	3.5	DB16-0106	0	11	3.5	DB16-0044
Left Cuspid	-7	9	3.5	DB16-0107	0	11	3.5	DB16-0045
Right Bicuspid	-7	0	3.0	DB16-0108	-7	0	3.0	DB16-0048
Left Bicuspid	-7	0	3.0	DB16-0109	-7	0	3.0	DB16-0049
Right Bicuspid w/ Hook	-7	0	3.0	DB16-0110	-7	0	3.0	DB16-0050
Left Bicuspid w/ Hook	-7	0	3.0	DB16-0111	-7	0	3.0	DB16-0051
Right Bicuspid & Offset	-7	0	3.0	DB16-0112	-7	0	3.0	DB16-0052
Left Bicuspid & Offset	-7	0	3.0	DB16-0113	-7	0	3.0	DB16-0053
Right Bicuspid w/ Hook & Offset	-7	0	3.0	DB16-0114	-7	0	3.0	DB16-0054
Left Bicuspid w/ Hook & Offset	-7	0	3.0	DB16-0115	-7	0	3.0	DB16-0055

MANDIBULAR ARCH

	MBT*.022				Roth*.022			
	Torq°	Angle°	Width (mm)	Code	Torq°	Angle°	Width (mm)	Code
Anterior Right	-6	0	2.5	DB16-0120	0	0	2.5	DB16-0056
Anterior Left	-6	0	2.5	DB16-0121	0	0	2.5	DB16-0057
Right Cuspid	-6	3	3.0	DB16-0122	-11	5	3.0	DB16-0058
Left Cuspid	-6	3	3.0	DB16-0123	-11	5	3.0	DB16-0059
Right Cuspid w/ Hook	-6	3 3	.0	DB16-0124	-11	5	3.0	DB16-0060
Left Cuspid w/ Hook	-6	3	3.0	DB16-0125	-11	5	3.0	DB16-0061
Right 1st Bicuspid	-12	2	3.0	DB16-0126	-17	0	3.0	DB16-0062
Left 1st Bicuspid	-12	2 3	.0	DB16-0127	-17	0	3.0	DB16-0063
Right 1st Bicuspid w/ Hook	-12	2	3.0	DB16-0130	-17	0	3.0	DB16-0064
Left 1st Bicuspid w/ Hook	-12	2	3.0	DB16-0131	-17	0	3.0	DB16-0065
Right 2nd Bicuspid	-17	2	3.0	DB16-0128	-22	0	3.0	DB16-0066
Left 2nd Bicuspid	-17	2	3.0	DB16-0129	-22	0	3.0	DB16-0067
Right 2nd Bicuspid w/ Hook	-17	2	3.0	DB16-0132	-22	0	3.0	DB16-0068
Left 2nd Bicuspid w/ Hook	-17	2	3.0	DB16-0133	-22	0	3.0	DB16-0069
Right 1st Bicuspid & Offset	-12	2	3.0	DB16-0134	-17	0	3.0	DB16-0070
Left 1st Bicuspid & Offset	-12	2	3.0	DB16-0135	-17	0	3.0	DB16-0071
Right 1st Bicuspid w/ Hook & Offset	-12	2	3.0	DB16-0138	-17	0	3.0	DB16-0072
Left 1st Bicuspid w/ Hook & Offset	-12	2	3.0	DB16-0139	-17	0	3.0	DB16-0073
Right 2nd Bicuspid & Offset	-17	2	3.0	DB16-0136	-22	0	3.0	DB16-0074
Left 2nd Bicuspid & Offset	-17	2	3.0	DB16-0137	-22	0	3.0	DB16-0075
Right 2nd Bicuspid w/ Hook & Offset	-17	2	3.0	DB16-0140	-22	0	3.0	DB16-0076
Left 2nd Bicuspid w/ Hook & Offset	-17	2	3.0	DB16-0141	-22	0	3.0	DB16-0077

*The prescriptions are not implied to be an exact version of any other system, nor do we claim any endorsement by the doctor(s).

Metalen brackets zijn verpakt per 10 stuks / Les brackets métalliques sont emballés par 10 pcs



Evolve Bracket system

Kits MBT*/Roth*

Bracket Kits MBT

	Code
Evolve MBT .022 Hks 3, 4, 5	DB16-0260
Evolve MBT .022 Hks 3	DB16-0261
Evolve MBT .022 Hks 3, 4 & 5 offset	DB16-0262
Evolve MBT .022 No Hks	DB16-0263
Evolve MBT .018 Hks 3, 4, 5	DB16-0264
Evolve MBT .018 Hks 3	DB16-0265

Bracket Kits Roth

	Code
Evolve Roth .022 Hks 3, 4, 5	DB16-0250
Evolve Roth .022 Hks 3	DB16-0251
Evolve Roth .018 Hks 3	DB16-0252
Evolve Roth .018 No Hks	DB16-0253
Evolve Roth .022 Hks 3, Offset 4 & 5	DB16-0254
Evolve Roth .018 Hks 3, 4, 5	DB16-0255

NEW & IMPROVED

Mushroom shaped hook

Secures chains and attachments and prevents slipping in between patient appointments.

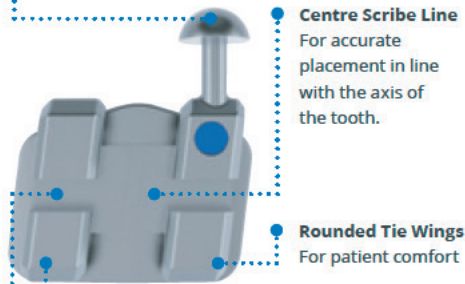

Centre Scribe Line

For accurate placement in line with the axis of the tooth.

Rounded Tie Wings

For patient comfort

Bevelled Tie Wings

To reduce visibility from the front without compromising on strength.

Ultra Low Friction Slot

CNC manufactured slot and advanced polishing process creates mirror finish by removing high surface peaks at molecular level.

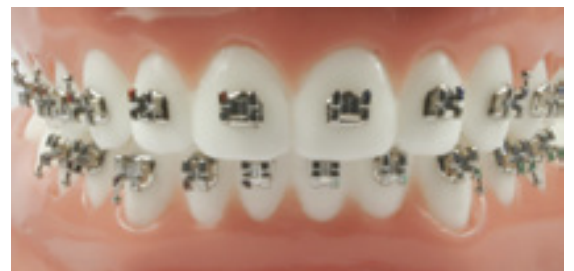

*The prescriptions are not implied to be an exact version of any other system, nor do we claim any endorsement by the doctor(s).





Rhodium BRACKETS





EXPERIENCE mini Rhodium



Experience mini RHODIUM Type Roth

MAXILLARY

Tooth	Torque	Angulation	Rotation	.018"		.022"	
				R	L	R	L
U1	12°T	5°A	0°	24-1110-0010	24-1210-0010	24-2110-0010	24-2210-0010
U2	8°T	9°A	0°	24-1120-0010	24-1220-0010	24-2120-0010	24-2220-0010
U3/Hk	-2°T	13°A	4°m	24-113D-0010	24-123D-0010	24-213D-0010	24-223D-0010
U4-5	-7°T	0°A	2°d	24-1140-0010	24-1240-0010	24-2140-0010	24-2240-0010
U4-5/Hk distal	-7°T	0°A	2°d	24-114D-0010	24-124D-0010	24-214D-0010	24-224D-0010

MANDIBULAR

Tooth	Torque	Angulation	Rotation	.018"		.022"	
				R	L	R	L
L1-2	-1°T	2°A	0°	24-1410-0010	24-1310-0010	24-2410-0010	24-2310-0010
L3/Hk	-11°T	7°A	2°m	24-143D-0010	24-133D-0010	24-243D-0010	24-233D-0010
L4	-17°T	-1°A	4°d	24-1440-0010	24-1340-0010	24-2440-0010	24-2340-0010
L4/Hk	-17°T	-1°A	4°d	24-144D-0010	24-134D-0010	24-244D-0010	24-234D-0010
L5	-22°T	-1°A	4°d	24-1450-0010	24-1350-0010	24-2450-0010	24-2350-0010
L5/Hk	-22°T	-1°A	4°d	24-145D-0010	24-135D-0010	24-245D-0010	24-235D-0010

Experience mini RHODIUM Type MBT* *MBT is a trade of 3M Unitek. All rights reserved.

MAXILLARY

Tooth	Torque	Angulation	Rotation	.018"		.022"	
				R	L	R	L
U1	17°	4°	0°	24-1110-0020	24-1210-0020	24-2110-0020	24-2210-0020
U2	10°	8°	0°	24-1120-0020	24-1220-0020	24-2120-0020	24-2220-0020
U3/Hk	-7°	8°	0°	24-113D-0020	24-123D-0020	24-213D-0020	24-223D-0020
U3/Hk/Opt	0°	8°	0°	24-113D-0021	24-123D-0021	24-213D-0021	24-223D-0021
U4-5/Hk	-7°	0°	0°	24-114D-0020	24-124D-0020	24-214D-0020	24-224D-0020
U4-5	-7°	0°	0°	24-1540-0020	24-1540-0020	24-2540-0020	24-2540-0020
U5/Hk/(Opt)	-7°	0°	0°	24-115D-0020	24-125D-0020	24-215D-0020	24-225D-0020
U5/(Opt)	-7°	0°	0°	24-1550-0020	24-1550-0020	24-2550-0020	24-2550-0020

MANDIBULAR

Tooth	Torque	Angulation	Rotation	.018"		.022"	
				R	L	R	L
L1-2	-6°	0°	0°	24-1610-0020	24-1610-0020	24-2610-0020	24-2610-0020
U3/Hk	-6°	3°	0°	24-143D-0020	24-133D-0020	24-243D-0020	24-233D-0020
U3/Hk/Opt	0°	3°	0°	24-143D-0021	24-133D-0021	24-243D-0021	24-233D-0021
L4	-12°	2°	0°	24-1440-0020	24-1340-0020	24-2440-0020	24-2340-0020
L4/Hk	-12°	2°	0°	24-144D-0020	24-134D-0020	24-244D-0020	24-234D-0020
L5	-17°	2°	0°	24-1450-0020	24-1350-0020	24-2450-0020	24-2350-0020
L5/Hk	-17°	2°	0°	24-145D-0020	24-135D-0020	24-245D-0020	24-235D-0020

OPTIONAL BRACKETS

Tooth	Torque	Angulation	Rotation	.018"		.022"	
				R	L	R	L
U4-5	0°	0°	0°	24-1540-0025	24-1540-0025	24-2540-0025	24-2540-0025



EXPERIENCE mini Rhodium



Experience mini RHODIUM, Type Roth .020" x .028"

MAXILLARY

Tooth	Torque	Angulation	Rotation	R	L
U 1 .020" x .028"	12°	5°	0°	24-5110-0010	24-5210-0010
U 2 .020" x .028"	8°	9°	0°	24-5120-0010	24-5220-0010

MANDIBULAR

Tooth	Torque	Angulation	Rotation	R	L
L 1/2 .020" x .028"	-1°	2°	0°	24-5410-0010	24-5310-0010

Experience mini RHODIUM



MAXILLARY

Tooth	Torque	Angulation	Rotation	R	L
U1 .020" x .028"	12°	5°	0°	24-5110-0500	24-5210-0500
U2 .020" x .028"	8°	9°	0°	24-5120-0500	24-5220-0500
U3 .022" x .028"	0°	11°	0°	24-213D-0500	24-223D-0500
U4-5 .022" x .028"	-10°	4°	2°d	24-2140-0500	24-2240-0500
U4-5/Hk .022" x .028"	-10°	4°	2°d	24-214M-0500	24-224M-0500

MANDIBULAR

Tooth	Torque	Angulation	Rotation	R	L
L1-2 .020" x .028"	-1°	2°	0°	24-5410-0500	24-5310-0500
L3/Hk .022" x .028"	-3°	3°	0°	24-243D-0500	24-233D-0500
L4 .022" x .028"	-17°	1°	4°d	24-2440-0500	24-2340-0500
L4/Hk .022" x .028"	-17°	1°	4°d	24-244D-0500	24-234D-0500
L5 .022" x .028"	-22°	1°	4°d	24-2450-0500	24-2350-0500
L5/Hk .022" x .028"	-22°	1°	4°d	24-245D-0500	24-235D-0500

Rhodium brackets zijn verpakt per 10 stuks / Les brackets Rhodium sont emballés par 10 pcs

Experience mini RHODIUM Kits

Prescription	Upper arch	Lower arch	Hook on	.018"	.022"
Experience Mini Rhodium ROTH	5-5	5-5	3	24-1CC3-0010	24-2CC3-0010
Experience Mini Rhodium ROTH	5-5	5-5	3,4,5	24-1CC5-0010	24-2CC5-0010
Experience Mini Rhodium MBT	5-5	5-5	3	24-1CC3-0020	24-2CC3-0020
Experience Mini Rhodium MBT	5-5	5-5	3,4,5	24-1CC5-0020	24-2CC5-0020
G.E.T.	5-5	5-5	3	-	24-5CC3-0500
G.E.T.	5-5	5-5	3,4,5	-	24-5CC5-0500
G.E.T.	5-5	5-5	3	-	24-5AA3-0500
G.E.T.	5-5	5-5	3,4,5	-	24-5AA5-0500



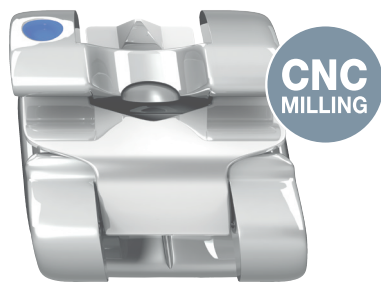

EXPERIENCE metal Rhodium



Experience RHODIUM, Type Roth MAXILLARY

Tooth	Torque	Angulation	Rotation	.018"		.022"	
				R	L	R	L
U1	12°	5°	0°	19-1110-0010	19-1210-0010	19-2110-0010	19-2210-0010
U2	8°	9°	0°	19-1120-0010	19-1220-0010	19-2120-0010	19-2220-0010
U3/Hk	-2°	13°	4°m	19-113D-0010	19-123D-0010	19-213D-0010	19-223D-0010
U4-5	-7°	0°	2°d	19-1140-0010	19-1240-0010	19-2140-0010	19-2240-0010
U4-5/Hk d	-7°	0°	2°d	19-114D-0010	19-124D-0010	19-214D-0010	19-224D-0010

MANDIBULAR

Tooth	Torque	Angulation	Rotation	.018"		.022"	
				R	L	R	L
L1-2	-1°	2°	0°	19-1410-0010	19-1310-0010	19-2410-0010	19-2310-0010
L3/Hk	-11°	7°	2°m	19-143D-0010	19-133D-0010	19-243D-0010	19-233D-0010
L4	-17°	-1°	4°d	19-1440-0010	19-1340-0010	19-2440-0010	19-2340-0010
L4/Hk	-17°	-1°	4°d	19-144D-0010	19-134D-0010	19-244D-0010	19-234D-0010
L5	-22°	-1°	4°d	19-1450-0010	19-1350-0010	19-2450-0010	19-2350-0010
L5/Hk	-22°	-1°	4°d	19-145D-0010	19-135D-0010	19-245D-0010	19-235D-0010

Experience RHODIUM, Type MBT*

*MBT is a trade of 3M Unitek. All rights reserved.

MAXILLARY

Tooth	Torque	Angulation	Rotation	.018"		.022"	
				R	L	R	L
U1	17°	4°	0°	19-1110-0020	19-1210-0020	19-2110-0020	19-2210-0020
U2	10°	8°	0°	19-1120-0020	19-1220-0020	19-2120-0020	19-2220-0020
U3/Hk	-7°	8°	0°	19-113D-0020	19-123D-0020	19-213D-0020	19-223D-0020
U3/Hk	0°	8°	0°	19-113D-0021	19-123D-0021	19-213D-0021	19-223D-0021
U4-5	-7°	0°	0°	19-1540-0020	19-1540-0020	19-2540-0020	19-2540-0020
U4-5/Hk d	-7°	0°	0°	19-114D-0020	19-124D-0020	19-214D-0020	19-224D-0020

MANDIBULAR

Tooth	Torque	Angulation	Rotation	.018"		.022"	
				R	L	R	L
L1-2	-6°	0°	0°	19-1610-0020	19-1610-0020	19-2610-0020	19-2610-0020
L3/Hk	-6°	3°	0°	19-143D-0020	19-133D-0020	19-243D-0020	19-233D-0020
L3/Hk	0°	3°	0°	19-143D-0021	19-133D-0021	19-243D-0021	19-233D-0021
L4	-12°	2°	0°	19-1440-0020	19-1340-0020	19-2440-0020	19-2340-0020
L4/Hk	-12°	2°	0°	19-144D-0020	19-134D-0020	19-244D-0020	19-234D-0020
L5	-17°	2°	0°	19-1450-0020	19-1350-0020	19-2450-0020	19-2350-0020
L5/Hk	-17°	2°	0°	19-145D-0020	19-135D-0020	19-245D-0020	19-235D-0020

Rhodium brackets zijn verpakt per 10 stuks / Les brackets Rhodium sont emballés par 10 pcs

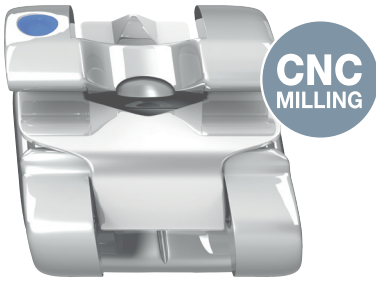

EXPERIENCE

metal Rhodium



Kits Experience RHODIUM

Prescription	Upper arch	Lower arch	Hook on	.018"	.022"
Experience Rhodium ROTH	5-5	5-5	3	19-1CC3-0010	19-2CC3-0010
Experience Rhodium ROTH	5-5	5-5	3,4,5	19-1CC5-0010	19-2CC5-0010
Experience Rhodium MBT	5-5	5-5	3	19-1CC3-0020	19-2CC3-0020
Experience Rhodium MBT	5-5	5-5	3,4,5	19-1CC5-0020	19-2CC5-0020



What is GET?

GOALS

What are our ideal aesthetic, functional and occlusal treatment goals?

EVIDENCE

What evidence is available to support our decisions?

TREATMENT

What is the best realistic treatment option considering the boundaries of everyday practice and according to sound biomechanical principles?

SPEAKERS



Dr. Stefano Troiani

Private practice of Orthodontics, Siegen, Germany graduated at the University of Aarhus (DK) orthodontic program and received his MSc in Orthodontics in 2003. He has maintained a private practice in Denmark since 2003 and in Germany since 2008. He has worked as Clinical Assistant Professor at the Dept. of Orthodontics of the University of Aarhus from 2005 to 2007. He has been the scientific director of the Alpe Adria Face Master held at the University of Graz, Ljubljana and Zagreb in 2012-2013. He has been consultant orthodontist at the department of maxillo-facial surgery of the hospital of Sønderborg (Denmark) from 2008 to 2009. He is consultant orthodontist at the department of maxillo-facial surgery of the university hospital of Odense (Denmark) from 2008 to present.

follow him on facebook Kieferorthopäde Stefano Troiani



Dr. Marc Geserik

Graduated in Dentistry at the University of Ulm (D) and his Dentist training at the University of Basel (CH). In addition, he completed a law degree in medical law.

Since 2005 he runs his private practice in Ulm (D) and since 2006 worldwide pursued his lecturer activity, connected with numerous publications. He spent some times abroad and took place at the University of Kandy (Sri Lanka), the University of Tsurumi (Japan) and the University of Southern California in the USA. He also completed that Further education program Bioesthetic Level I-II and Postgraduate Roth / Williams 2 years program and postgraduate SWING Philosophy under dr. Javier Frenk.

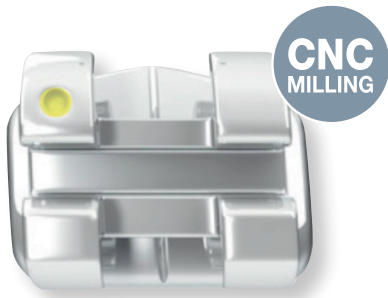

LEGEND medium Rhodium



Legend Medium RHODIUM, Roth Type with vertical slot

MAXILLARY

Tooth	Torque	Angulation	.018"		.022"	
			R	L	R	L
U1	12°T	5°A	39-1110-0034	39-1210-0034	39-2110-0034	39-2210-0034
U2	8°T	9°A	39-1120-0034	39-1220-0034	39-2120-0034	39-2220-0034
U3/Hk	0°T	7°A	39-113D-0040	39-123D-0040	39-213D-0040	39-223D-0040
U4-5	-7°T	0°A	39-1540-0034	39-1540-0034	39-2540-0034	39-2540-0034
UR4/5 HK	-7°T	0°A	39-114M-0034	39-124M-0034	39-214M-0034	39-224M-0034

MANDIBULAR

Tooth	Torque	Angulation	.018"		.022"	
			R	L	R	L
L1-2	0°T	0°A	39-1610-0034	39-1610-0034	39-2610-0034	39-2610-0034
L3/Hk	0°T	5°A	39-143D-0040	39-133D-0040	39-243D-0040	39-233D-0040
L4	-11°T	0°A	39-1640-0034	39-1640-0034	39-2640-0034	39-2640-0034
L5	-17°T	0°A	39-1650-0034	39-1650-0034	39-2650-0034	39-2650-0034
L4/Hk	-11°T	0°A	39-144D-0034	39-134D-0034	39-244D-0034	39-234D-0034
L5/Hk	-17°T	0°A	39-145D-0034	39-135D-0034	39-245D-0034	39-235D-0034

Rhodium brackets zijn verpakt per 10 stuks / Les brackets Rhodium sont emballés par 10 pcs

Legend Medium RHODIUM, MBT Type with vertical slot

*MBT is a trade of 3M Unitek. All rights reserved.

MAXILLARY

Tooth	Torque	Angulation	.018"		.022"	
			R	L	R	L
U1	17°T	5°A	39-1110-0029	39-1210-0029	39-2110-0029	39-2210-0029
U2	8°T	9°A	39-1120-0034	39-1220-0034	39-2120-0034	39-2220-0034
U3/Hk	0°T	7°A	39-113D-0040	39-123D-0040	39-213D-0040	39-223D-0040
U4-5	-7°T	0°A	39-1540-0034	39-1540-0034	39-2540-0034	39-2540-0034
UR4/5 HK	-7°T	0°A	39-114M-0034	39-124M-0034	39-214M-0034	39-224M-0034

MANDIBULAR

Tooth	Torque	Angulation	.018"		.022"	
			R	L	R	L
L1-2	-5°T	0°A	39-1610-0011	39-1610-0011	39-2610-0036	39-2610-0036
L3/Hk	0°T	5°A	39-143D-0040	39-133D-0040	39-243D-0040	39-233D-0040
L4	-11°T	0°A	39-1640-0034	39-1640-0034	39-2640-0034	39-2640-0034
L5	-17°T	0°A	39-1650-0034	39-1650-0034	39-2650-0034	39-2650-0034
L4/Hk	-11°T	0°A	39-144D-0034	39-134D-0034	39-244D-0034	39-234D-0034
L5/Hk	-17°T	0°A	39-145D-0034	39-135D-0034	39-245D-0034	39-235D-0034

Rhodium brackets zijn verpakt per 10 stuks / Les brackets Rhodium sont emballés par 10 pcs

LEGEND medium

Rhodium



Legend Medium RHODIUM, Ricketts Type with vertical slot

MAXILLARY

Tooth	Torque	Angulation	.018"		.022"	
			R	L	R	L
U1	22°T	5°A	39-1110-0028	39-1210-0028	39-2110-0028	39-2210-0028
U2	14°T	9°A	39-1120-0028	39-1220-0028	39-2120-0028	39-2220-0028
U3/Hk	7°T	5°A	39-113D-0028	39-123D-0028	39-213D-0028	39-223D-0028
U4-5	0°T	0°A	39-1540-0040	39-1540-0040	39-2540-0040	39-2540-0040

MANDIBULAR

Tooth	Torque	Angulation	.018"		.022"	
			R	L	R	L
L1-2	0°T	0°A	39-1610-0034	39-1610-0034	39-2610-0034	39-2610-0034
L3/Hk	7°T	5°A	39-123D-0028	39-113D-0028	39-223D-0028	39-213D-0028
L4-5	0°T	0°A	39-1640-0040	39-1640-0040	39-2640-0040	39-2640-0040

Rhodium brackets zijn verpakt per 10 stuks / Les brackets Rhodium sont emballés par 10 pcs



LEGEND mini Rhodium



Legend Mini RHODIUM, Roth Type MAXILLARY

Tooth	Torque	Ang.	Rotation	.018"		.022"	
				R	L	R	L
U1	12°	5°	0°	38-1110-0010	38-1210-0010	38-2110-0010	38-2210-0010
U2	8°	9°	0°	38-1120-0010	38-1220-0010	38-2120-0010	38-2220-0010
U3/Hk	2°	10°	4°m	38-113D-0010	38-123D-0010	38-213D-0010	38-223D-0010
U4	-7°	0°	2°d	38-1140-0010	38-1240-0010	38-2140-0010	38-2240-0010
U4/Hk	-7°	0°	2°d	38-114M-0010	38-124M-0010	38-214M-0010	38-224M-0010
U5	-7°	0°	2°d	38-1150-0010	38-1250-0010	38-2150-0010	38-2250-0010
U5/Hk	-7°	0°	2°d	38-115M-0010	38-125M-0010	38-215M-0010	38-225M-0010

MANDIBULAR

Tooth	Torque	Ang.	Rotation	.018"		.022"	
				R	L	R	L
L1-2	-1°	0°	0°	38-1610-0010	38-1610-0010	38-2610-0010	38-2610-0010
L3/Hk	-11°	7°	2°m	38-143D-0010	38-133D-0010	38-243D-0010	38-233D-0010
L4	-17°	0°	4°d	38-1440-0010	38-1340-0010	38-2440-0010	38-2340-0010
L4/Hk	-17°	0°	4°d	38-144D-0010	38-134D-0010	38-244D-0010	38-234D-0010
L5	-22°	0°	4°d	38-1450-0010	38-1350-0010	38-2450-0010	38-2350-0010
L5/Hk	-22°	0°	4°d	38-145D-0010	38-135D-0010	38-245D-0010	38-235D-0010

Legend Mini RHODIUM, MBT *MBT is a trade of 3M Unitek. All rights reserved.

MAXILLARY

Tooth	Torque	Ang.	.018"		.022"	
			R	L	R	L
U1	17°	4°	38-1110-0020	38-1210-0020	38-2110-0020	38-2210-0020
U2	10°	8°	38-1120-0020	38-1220-0020	38-2120-0020	38-2220-0020
U3	-7°	8°	38-1130-0020	38-1230-0020	38-2130-0020	38-2230-0020
U3/Hk	-7°	8°	38-113D-0020	38-123D-0020	38-213D-0020	38-223D-0020
U4	-7°	0°	38-1540-0020	38-1540-0020	38-2540-0020	38-2540-0020
U4/Hk	-7°	0°	38-114D-0020	38-124D-0020	38-214D-0020	38-224D-0020
U5	-7°	0°	38-1550-0020	38-1550-0020	38-2550-0020	38-2550-0020
U5/Hk	-7°	0°	38-115D-0020	38-125D-0020	38-215D-0020	38-225D-0020

MANDIBULAR

Tooth	Torque	Ang.	.018"		.022"	
			R	L	R	L
L 1-2	-6°	0°	38-1610-0020	38-1610-0020	38-2610-0020	38-2610-0020
L 3	-6°	3°	38-1430-0020	38-1330-0020	38-2430-0020	38-2330-0020
L 3/Hk	-6°	3°	38-143D-0020	38-133D-0020	38-243D-0020	38-233D-0020
L 4	-12°	2°	38-1440-0020	38-1340-0020	38-2440-0020	38-2340-0020
L 4/Hk	-12°	2°	38-144D-0020	38-134D-0020	38-244D-0020	38-234D-0020
L 5	-17°	2°	38-1450-0020	38-1350-0020	38-2450-0020	38-2350-0020
L 5/Hk	-17°	2°	38-145D-0020	38-135D-0020	38-245D-0020	38-235D-0020

Rhodium brackets zijn verpakt per 10 stuks / Les brackets Rhodium sont emballés par 10 pcs

Kits Legend Mini RHODIUM

Hook on	.018"		.022"	
	Mini MBT Type	Mini Roth Type	Mini MBT Type	Mini Roth Type
3	3	38-1CC3-0020	38-2CC3-0020	38-2CC3-0010
3,4,5	3,4,5	38-1CC5-0020	38-2CC5-0020	38-2CC5-0010

TYPODONTS

Rhodium



TYPODONT Conventional Rhodium brackets

Legend Mini

	Ref.
With hinge 7-7	55-3811-0000

Legend Medium

	Ref.
With hinge 7-7	55-3911-0000

TYPODONT Self-Ligating Rhodium brackets

EXPERIENCE RHODIUM

	Ref.
With hinge 7-7	55-1911-0000



50-0032-0000
For Experience Mini metal/rhodium



50-0030-0000
For Experience metal/ceramic
and rhodium



50-2030-0000
For Experience metal/rhodium







Keramische/Céramiques BRACKETS



Chic. Type Roth*



CHIC. Type Roth MAXILLARY

Tooth	Torque	Angulation	P/N			
			.018"		.022"	
			R	L	R	L
U 1	12°	5°	14-1110-0010	14-1210-0010	14-2110-0010	14-2210-0010
U 2	8°	9°	14-1120-0010	14-1220-0010	14-2120-0010	14-2220-0010
U 3	-2°	13°	14-1130-0010	14-1230-0010	14-2130-0010	14-2230-0010
U 3/Hk	-2°	13°	14-113D-0010	14-123D-0010	14-213D-0010	14-223D-0010
U 4-5	-7°	0°	14-1540-0010	14-1540-0010	14-2540-0010	14-2540-0010
U 4-5/Hk	-7°	0°	14-114D-0010	14-124D-0010	14-214D-0010	14-224D-0010

MANDIBULAR

Tooth	Torque	Angulation	P/N			
			.018"		.022"	
			R	L	R	L
L 1-2	0°	0°	14-1610-0010	14-1610-0010	14-2610-0010	14-2610-0010
L 3	-11°	7°	14-1430-0010	14-1330-0010	14-2430-0010	14-2330-0010
L 3/Hk	-11°	7°	14-143D-0010	14-133D-0010	14-243D-0010	14-233D-0010
L 4	-17°	0°	14-1640-0010	14-1640-0010	14-2640-0010	14-2640-0010
L 4/Hk	-17°	0°	14-144D-0010	14-134D-0010	14-244D-0010	14-234D-0010
L 5	-22°	0°	14-1650-0010	14-1650-0010	14-2650-0010	14-2650-0010
L 5/Hk	-22°	0°	14-145D-0010	14-135D-0010	14-245D-0010	14-235D-0010

Keramische brackets zijn verpakt per 5 stuks /
Les brackets céramiques sont emballés par 5 pcs

GC Orthodontics version of the **MBT™ System** prescription
(McLaughlin, Bennet or Trevisi) and is not a copy of existing system.
No endorsement by the Drs McLaughlin, Bennett or Trevisi is implied.

GC Orthodontics version of the **Roth System** prescription
and is not a copy of existing system.
No endorsement by Dr Roth is implied.





Chic. Type MBT*



CHIC. Type MBT*

MAXILLARY

Tooth	I/Omm	Torque	Angulation	P/N		P/N	
				.018"		.022"	
				R	L	R	L
U 1	0.80	17°	4°	14-1110-0020	14-1210-0020	14-2110-0020	14-2210-0020
U 2	1.32	10°	8°	14-1120-0020	14-1220-0020	14-2120-0020	14-2220-0020
U 3/Hk	0.73	-7°	8°	14-113D-0020	14-123D-0020	14-213D-0020	14-223D-0020
U 3/Hk	0.73	0°	8°	14-113D-0021	14-123D-0021	14-213D-0021	14-223D-0021
U 4-5	0.77	-7°	0°	14-1540-0020	14-1540-0020	14-2540-0020	14-2540-0020
U 5/(Optional)	1.07	-7°	0°	14-1550-0020	14-1550-0020	14-2550-0020	14-2550-0020
U 4-5/Hk	0.77	-7°	0°	14-114D-0020	14-124D-0020	14-214D-0020	14-224D-0020

MANDIBULAR

Tooth	I/Omm	Torque	Angulation	P/N		P/N	
				.018"		.022"	
				R	L	R	L
L 1-2	1.26	-6°	0°	14-1610-0020	14-1610-0020	14-2610-0020	14-2610-0020
L 3/Hk	0.83	-6°	3°	14-143D-0020	14-133D-0020	14-243D-0020	14-233D-0020
L 3/Hk	0.83	0°	3°	14-143D-0021	14-133D-0021	14-243D-0021	14-233D-0021
L 4	0.95	-12°	0°	14-1640-0020	14-1640-0020	14-2640-0020	14-2640-0020
L 4/Hk	0.95	-12°	0°	14-144D-0020	14-134D-0020	14-244D-0020	14-234D-0020
L 5	0.95	-17°	0°	14-1650-0020	14-1650-0020	14-2650-0020	14-2650-0020
L 5/Hk	0.95	-17°	0°	14-145D-0020	14-135D-0020	14-245D-0020	14-235D-0020

Keramische brackets zijn verpakt per 5 stuks / Les brackets céramiques sont emballés par 5 pcs

CHIC. KITS

Prescription	Upper	Lower	Hook on	P/N	
				.018"	.022"
Roth	3-3	—	3	14-1E03-0010	14-2E03-0010
Roth	3-3	3-3	3	14-1EE3-0010	14-2EE3-0010
Roth	5-5	—	3	14-1C03-0010	14-2C03-0010
Roth	5-5	3-3	3	14-1CE3-0010	14-2CE3-0010
Roth	5-5	5-5	3	14-1CC3-0010	14-2CC3-0010
Roth	5-5	3-3	3,4,5	14-1CE5-0010	14-2CE5-0010
Roth	5-5	5-5	3,4,5	14-1CC5-0010	14-2CC5-0010
Type MBT	3-3	—	3	—	14-2E03-0020
Type MBT	5-5	—	3	14-1C03-0020	14-2C03-0020
Type MBT	5-5	3-3	3	—	14-2CE3-0020
Type MBT	5-5	5-5	3	14-1CC3-0020	14-2CC3-0020
Type MBT	5-5	3-3	3,4,5	—	14-2CE5-0020
Type MBT	5-5	5-5	3,4,5	14-1CC5-0020	14-2CC5-0020



EXPERIENCE ceramic

Type Roth*



EXPERIENCE CERAMIC Type Roth

MAXILLARY

Tooth	I/O mm	Torque	Angulation	Rotation	P/N			
					.018"		.022"	
					R	L	R	L
U 1	.81	12°	5°	0°	11-1110-0010	11-1210-0010	11-2110-0010	11-2210-0010
U 2	1.07	8°	9°	0°	11-1120-0010	11-1220-0010	11-2120-0010	11-2220-0010
U 3	.46	-2°	13°	4°m	11-1130-0010	11-1230-0010	11-2130-0010	11-2230-0010
U 3/Hk	.46	-2°	13°	4°m	11-113D-0010	11-123D-0010	11-213D-0010	11-223D-0010
U 4-5	.46	-7°	0°	2°d	11-1140-0010	11-1240-0010	11-2140-0010	11-2240-0010
U 4-5/Hk	.46	-7°	0°	2°d	11-114D-0010	11-124D-0010	11-214D-0010	11-224D-0010

MANDIBULAR

Tooth	I/O mm	Torque	Angulation	Rotation	P/N			
					.018"		.022"	
					R	L	R	L
L 1-2	1.17	-1°	2°	0°	11-1410-0010	11-1310-0010	11-2410-0010	11-2310-0010
L 3	.56	-11°	7°	2°m	11-1430-0010	11-1330-0010	11-2430-0010	11-2330-0010
L 3/Hk	.56	-11°	7°	2°m	11-143D-0010	11-133D-0010	11-243D-0010	11-233D-0010
L 4(zirconium)	.38	-17°	0°	4°d	11-1440-Z010	11-1340-Z010	11-2440-Z010	11-2340-Z010
L 4/Hk/ (zirc.)	.38	-17°	0°	4°d	11-144D-Z010	11-134D-Z010	11-244D-Z010	11-234D-Z010
L 5(zirconium)	.28	-22°	0°	4°d	11-1450-Z010	11-1350-Z010	11-2450-Z010	11-2350-Z010
L 5/Hk(zirc.)	.28	-22°	0°	4°d	11-145D-Z010	11-135D-Z010	11-245D-Z010	11-235D-Z010

EXPERIENCE CERAMIC Type Roth .020"x .028"

Features an original slot size on upper and lower incisors: .020" x .028". Used in conjunction with .020"x .025" stainless steel archwires, the system controls the anterior torque and brings more rigidity to the buccal segments during space closure.

MAXILLARY

Tooth	I/O mm	Torque	Angulation	Rotation	P/N	
					R	L
U 1 .020" x .028"	.81	12°	5°	0°	11-5110-0010	11-5210-0010
U 2 .020" x .028"	1.07	8°	9°	0°	11-5120-0010	11-5220-0010
U 3 .022" x .028"/Hk	.46	0°	8°	2°m	11-213D-0030	11-223D-0030
U 4/5 .022" x .028"	.46	-7°	0°	2°d	11-2140-0010	11-2240-0010
U 4/5 .022" x .028"/Hk	.46	-7°	0°	2°d	11-214D-0010	11-224D-0010

MANDIBULAR

Tooth	I/O mm	Torque	Angulation	Rotation	P/N	
					R	L
L 1/2 .020" x .028"	1.17	0°	2°	0°	11-5410-0010	11-5310-0010
L 3 .022" x .028"/Hk	.56	-3°	7°	2°m	11-243D-0030	11-233D-0030
L 4* .022" x .028"/Hk/(zirc.)	.38	-17°	0°	4°d	11-244D-Z010	11-234D-Z010
L 5* .022" x .028"/Hk/(zirc.)	.28	-22°	0°	4°d	11-245D-Z010	11-235D-Z010

Keramische brackets zijn verpakt per 5 stuks /
Les brackets céramiques sont emballés par 5 pcs

Keramische/Céramiques BRACKETS



EXPERIENCE ceramic

Extra Torque



EXPERIENCE CERAMIC Extra Torque

This prescription is based on the use of less than full size archwires due to increased torque on the maxillary incisors. Increased buccal root torque in the upper bicuspids prevents any lingual cusp interference.

MAXILLARY

Tooth	I/O mm	Torque	Angulation	Rotation	P/N			
					.018"		.022"	
					R	L	R	L
U 1	.81	18°	5°	0°	11-1110-0030	11-1210-0030	11-2110-0030	11-2210-0030
U 2	1.07	10°	8°	0°	11-1120-0030	11-1220-0030	11-2120-0030	11-2220-0030
U 3	.46	0°	8°	2°m	11-1130-0030	11-1230-0030	11-2130-0030	11-2230-0030
U 3/Hk	.46	0°	8°	2°m	11-113D-0030	11-123D-0030	11-213D-0030	11-223D-0030
U 4-5	.46	-10°	4°	2°d	11-1140-0030	11-1240-0030	11-2140-0030	11-2240-0030
U 4-5/Hk	.46	-10°	4°	2°d	11-114D-0030	11-124D-0030	11-214D-0030	11-224D-0030

MANDIBULAR

Tooth	I/O mm	Torque	Angulation	Rotation	P/N			
					.018"		.022"	
					R	L	R	L
L 1-2	1.17	1°	0°	0°	11-1610-0030	11-1610-0030	11-2610-0030	11-2610-0030
L 3	.56	-3°	7°	2°m	11-1430-0030	11-1330-0030	11-2430-0030	11-2330-0030
L 3/Hk	.56	-3°	7°	2°m	11-143D-0030	11-133D-0030	11-243D-0030	11-233D-0030
L 4*/(Exp M)	.33	-7°	0°	2°d	20-1440-0030	20-1340-0030	20-2440-0030	20-2340-0030
L 4*/Hk/(Exp M)	.33	-7°	0°	2°d	20-144D-0030	20-134D-0030	20-244D-0030	20-234D-0030
L 5*/(Exp M)	.33	-7°	0°	2°d	20-1450-0030	20-1350-0030	20-2450-0030	20-2350-0030
L 5*/Hk/(Exp M)	.33	-7°	0°	2°d	20-145D-0030	20-135D-0030	20-245D-0030	20-235D-0030

* Since ceramic material is much harder than enamel, we recommend using EXPERIENCE metal brackets on mandibular bicuspids (L4, L5)

Keramische brackets zijn verpakt per 5 stuks /
Les brackets céramiques sont emballés par 5 pcs





EXPERIENCE ceramic

Type MBT*



EXPERIENCE CERAMIC Type MBT*

MAXILLARY

Tooth	I/O mm	Torque	Angulation	Rotation	P/N			
					.018"		.022"	
					R	L	R	L
U 1	.81	17°	4°	0°	11-1110-0020	11-1210-0020	11-2110-0020	11-2210-0020
U 2	1.07	10°	8°	0°	11-1120-0020	11-1220-0020	11-2120-0020	11-2220-0020
U 3/Hk	.46	-7°	8°	0°	11-113D-0020	11-123D-0020	11-213D-0020	11-223D-0020
U 3/Hk	.46	0°	8°	0°	11-113D-0021	11-123D-0021	11-213D-0021	11-223D-0021
U 4-5	.46	-7°	0°	0°	11-1540-0020	11-1540-0020	11-2540-0020	11-2540-0020
U 4-5/Hk	.46	-7°	0°	0°	11-114D-0020	11-124D-0020	11-214D-0020	11-224D-0020
U 5/(Optional)	.96	-7°	0°	0°	11-1550-0020	11-1550-0020	11-2550-0020	11-2550-0020
U 5/Hk/(Opt)	.96	-7°	0°	0°	11-115D-0020	11-125D-0020	11-215D-0020	11-225D-0020

MANDIBULAR

Tooth	I/O mm	Torque	Angulation	Rotation	P/N			
					.018"		.022"	
					R	L	R	L
L 1-2	1.17	-6°	0°	0°	11-1610-0020	11-1610-0020	11-2610-0020	11-2610-0020
L 3/Hk	.56	-6°	3°	0°	11-143D-0020	11-133D-0020	11-243D-0020	11-233D-0020
L 3/Hk	.56	0°	3°	0°	11-143D-0021	11-133D-0021	11-243D-0021	11-233D-0021
L 4	.33	-12°	0°	0°	11-1440-0020	11-1340-0020	11-2440-0020	11-2340-0020
L 4/Hk	.33	-12°	0°	0°	11-144D-0020	11-134D-0020	11-244D-0020	11-234D-0020
L 5	.33	-17°	0°	0°	11-1450-0020	11-1350-0020	11-2450-0020	11-2350-0020
L 5/Hk	.33	-17°	0°	0°	11-145D-0020	11-135D-0020	11-245D-0020	11-235D-0020

Keramische brackets zijn verpakt per 5 stuks /
Les brackets céramiques sont emballés par 5 pcs





EXPERIENCE ceramic Kits



EXPERIENCE ceramic Kits

Prescription	Upper arch	Lower arch	With Hook	P/N	
.020" x .028"					
Type Roth .020" x .028"	5-5	3-3	3	11-5CE3-0010	
Type Roth .020" x .028"	5-5	—	3	11-5C03-0010	
Prescription	Upper arch	Lower arch	With Hook	P/N	
.018" .022"					
Type MBT*	3-3	—	3	11-1E03-0020	11-2E03-0020
Type MBT*	3-3	3-3	3	11-1EE3-0020	11-2EE3-0020
Type MBT*	5-5	—	3	11-1C03-0020	11-2C03-0020
Type MBT*	5-5	—	3,4,5	11-1C05-0020	11-2C05-0020
Type MBT*	5-5	3-3	3	11-1CE3-0020	11-2CE3-0020
Type MBT*	5-5	3-3	3,4,5	11-1CE5-0020	11-2CE5-0020
Type MBT*	5-5	5-5	3	11-1CC3-0020	11-2CC3-0020
Type MBT*	5-5	5-5	3,4,5	11-1CC5-0020	11-2CC5-0020
Prescription	Upper arch	Lower arch	With Hook	P/N	
.018" .022"					
Type Roth	3-3	—	3	11-1E03-0010	11-2E03-0010
Type Roth	3-3	3-3	3	11-1EE3-0010	11-2EE3-0010
Type Roth	5-5	—	3	11-1C03-0010	11-2C03-0010
Type Roth	5-5	—	3,4,5	11-1C05-0010	11-2C05-0010
Type Roth	5-5	3-3	3	11-1CE3-0010	11-2CE3-0010
Type Roth	5-5	3-3	3,4,5	11-1CE5-0010	11-2CE5-0010
Type Roth (L 4-5 zirconium)	5-5	5-5	3	11-1CC3-M010	11-2CC3-M010
Type Roth (L 4-5 zirconium)	5-5	5-5	3,4,5	11-1CC5-M010	11-2CC5-M010
Prescription	Upper arch	Lower arch	With Hook	P/N	
.018" .022"					
Extra Torque	3-3	—	3	11-1E03-0030	11-2E03-0030
Extra Torque	3-3	3-3	3	11-1EE3-0030	11-2EE3-0030
Extra Torque	5-5	—	3	11-1C03-0030	11-2C03-0030
Extra Torque	5-5	—	3,4,5	11-1C05-0030	11-2C05-0030
Extra Torque	5-5	3-3	3	11-1CE3-0030	11-2CE3-0030
Extra Torque	5-5	3-3	3,4,5	11-1CE5-0030	11-2CE5-0030
Prescription	Upper arch	Lower arch	With Hook	P/N	
.020" x .028"					
ACO	5-5	5-5	3	11-2CC3-M007	
ACO	5-5	5-5	3,4,5	11-2CC5-M007	



EXPERIENCE ceramic ACO

EXPERIENCE CERAMIC ACO MAXILLARY

Tooth	I/O mm	Torque	Angulation	P/N .022" x.028"	
				R	L
U 1	.81	12°	5°	11-2110-0007	11-2210-0007
U 2	1.07	10°	9°	11-2120-0007	11-2220-0007
U 3/Hk	.46	-7°	10°	11-213D-0007	11-223D-0007
U 4-5	.46	-9°	0°	11-2540-0007	11-2540-0007
U 4-5/Hk	.46	-9°	0°	11-214D-0007	11-224D-0007

MANDIBULAR

Tooth	I/O mm	Torque	Angulation	P/N .022" x.028"	
				R	L
L 1/2	1.17	-6°	0°	11-2610-0007	11-2610-0007
L 3/Hk	.56	-8°	3°	11-243D-0007	11-233D-0007
L 4	.38	-12°	0°	11-2440-0020	11-2340-0020
L 4/Hk	.38	-12°	0°	11-244D-0020	11-234D-0020
L 5	.38	-17°	0°	11-2450-0020	11-2350-0020
L 5/Hk	.38	-17°	0°	11-245D-0020	11-235D-0020



EXPERIENCE ceramic Optional



OPTIONAL BRACKETS

Tooth	Torque	Angulation	Rotation	P/N			
				.018"	.022"	.022"	.022"
U 3/Hk	7°	5°	0°	11-113D-0027	11-123D-0027	11-213D-0027	11-223D-0027
U 4 Univ	0°	0°	0°	11-1540-0025	11-1540-0025	11-2540-0025	11-2540-0025

Keramische brackets zijn verpakt per 5 stuks / Les brackets céramiques sont emballés par 5 pcs

Instruments for working with EXPERIENCE brackets:



C-Tool: Features both a double forked end to facilitate wire insertion and an end with a hollow ball to safely open the bracket from the gingival side.

P/N. **50-1030-0000**



Open Tool: Is a double ended instrument that features a hollow ball, which aids in opening EXPERIENCE brackets from either the buccal (hook) or gingival (safety) side.

P/N. **50-0030-0000**



20%
smaller than
the Experience
Ceramic

EXPERIENCE mini ceramic Type MBT* en Roth*



EXPERIENCE mini Ceramic Type MBT

MAXILLARY

Tooth	Torque	Angulation	.018		.022	
			R	L	R	L
U1	17°T	4°A	12-1110-0020	12-1210-0020	12-2110-0020	12-2210-0020
U2	10°T	8°A	12-1120-0020	12-1220-0020	12-2120-0020	12-2220-0020
U3 with hook	0°T	8°A	12-113D-0021	12-123D-0021	12-213D-0021	12-223D-0021
U4 univ	-7°T	0°A	12-1540-0020	12-1540-0020	12-2540-0020	12-2540-0020
U4&5 with hook	-7°T	0°A	12-114D-0020	12-124D-0020	12-214D-0020	12-224D-0020

MANDIBULAR

Tooth	Torque	Angulation	.018		.022	
			R	L	R	L
L1-2	-6°T	0°A	12-1610-0020	12-1610-0020	12-2610-0020	12-2610-0020
L3 with hook	0°T	3°A	12-143D-0021	12-133D-0021	12-243D-0021	12-233D-0021
L4	-12°T	2°A	12-1440-0020	12-1340-0020	12-2440-0020	12-2340-0020
L4 with hook	-12°T	2°A	12-144D-0020	12-134D-0020	12-244D-0020	12-234D-0020
L5	-17°T	2°A	12-1450-0020	12-1350-0020	12-2450-0020	12-2350-0020
L5 with hook	-17°T	2°A	12-145D-0020	12-135D-0020	12-245D-0020	12-235D-0020

Keramische brackets zijn verpakt per 5 stuks / Les brackets céramiques sont emballés par 5 pcs

EXPERIENCE mini Ceramic Type Roth

MAXILLARY

Tooth	I/O mm	Torque	Ang.	Rotation	.018		.022	
					R	L	R	L
U1	.81	12°T	5°A	0°	12-1110-0010	12-1210-0010	12-2110-0010	12-2210-0010
U2	1.07	8°T	9°A	0°	12-1120-0010	12-1220-0010	12-2120-0010	12-2220-0010
U3/hook	.46	-2°T	13°A	4°m	12-113D-0010	12-123D-0010	12-213D-0010	12-223D-0010
U4-5/hook	.46	-7°T	0°A	2°d	12-114D-0010	12-124D-0010	12-214D-0010	12-224D-0010

MANDIBULAR

Tooth	I/O mm	Torque	Ang.	Rotation	.018		.022	
					R	L	R	L
L1-2	1.17	-1°T	2°A	0°	12-1410-0010	12-1310-0010	12-2410-0010	12-2310-0010
L3/hook	.56	-11°T	7°A	2°m	12-143D-0010	12-133D-0010	12-243D-0010	12-233D-0010
L4/hook	.38	-17°T	0°A	4°d	12-144D-0010	12-134D-0010	12-244D-0010	12-234D-0010
L5/hook	.28	-22°T	0°A	4°d	12-145D-0010	12-135D-0010	12-245D-0010	12-235D-0010

KITS mini Ceramic

Prescription	Upper	Lower	Hook on	.018	.022
Type Roth	5-5	5-5	3,4,5	12-1CC5-0010	12-2CC5-0010
Type MBT	5-5	5-5	3,4,5	12-1CC5-0020	12-2CC5-0020



AGILITY ceramic Type Roth*

AGILITY CERAMIC Type Roth Sold in packages of 5

MAXILLARY Roth¹ Rx

Tooth	Torque	Angle	Rotation	M/D	R/L	ID	.018	.022
Central	12°	5°	0°	3.9 mm	R	●	127-U1-8R-V	127-U1-2R-V
					L	●	127-U1-8L-V	127-U1-2L-V
Lateral	8°	9°	0°	3.3 mm	R	○	127-U2-8R-V	127-U2-2R-V
					L	○	127-U2-8L-V	127-U2-2L-V
Cuspid (without Hook)	0°	11°	0°	3.4 mm	R	●	127-U3-8R-V	127-U3-2R-V
					L	●	127-U3-8L-V	127-U3-2L-V
Cuspid Hk (with Hook)	0°	11°	0°	3.4 mm	R	●	127-U3-8RK-V	127-U3-2RK-V
					L	●	127-U3-8LK-V	127-U3-2LK-V
1 st & 2 nd Bicuspid	-7°	0°	0°	3.4 mm	U	●●	127-U4-8U-V	127-U4-2U-V
1 st & 2 nd Bicuspid Hk	-7°	0°	0°	3.4 mm	R	●	127-U4-8RK-V	127-U4-2RK-V
					L	●	127-U4-8LK-V	127-U4-2LK-V

MANDIBULAR Roth¹ Rx

Tooth	Torque	Angle	Rotation	M/D	R/L	ID	.018	.022
Anterior	0°	0°	0°	2.6 mm	U	●●	127-L1-8U-V	127-L1-2U-V
Cuspid (without Hook)	-11°	5°	0°	3.4 mm	R	●	127-L3-8R-V	127-L3-2R-V
					L	●	127-L3-8L-V	127-L3-2L-V
Cuspid Hk (with Hook)	-11°	5°	0°	3.4 mm	R	●	127-L3-8RK-V	127-L3-2RK-V
					L	●	127-L3-8LK-V	127-L3-2LK-V
1 st Bicuspid	-17°	0°	0°	3.4 mm	U	●●	127-L4-8U-V	127-L4-2U-V
1 st Bicuspid Hk	-17°	0°	0°	3.4 mm	R	●	127-L4-8RK-V	127-L4-2RK-V
					L	●	127-L4-8LK-V	127-L4-2LK-V
2 nd Bicuspid	-22°	0°	0°	3.4 mm	U	●●	127-L5-8U-V	127-L5-2U-V
2 nd Bicuspid Hk	-22°	0°	0°	3.4 mm	R	●	127-L5-8RK-V	127-L5-2RK-V
					L	●	127-L5-8LK-V	127-L5-2LK-V

BRACKET KITS Roth¹ Rx

20 brackets per kit	.018	.022
Upper/Lower 5x5 Hook on 3	19K-3-18-01	19K-3-22-01
Upper/Lower 5x5 Hook on 3, 4, & 5	19K-345-18-01	19K-345-22-01

Brackets are packaged with 1 case oriented in a kit box.

Brackets are also available in kits of 5 or 10 cases oriented in a carousel dispenser.



Agility™ Twin Bracket
kit, 20 brackets
oriented in a kit box

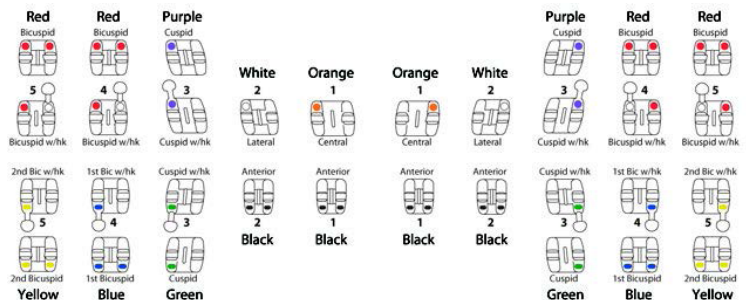

**MBT is a trademark of 3M Unitek Corporation.

G&H® prescriptions are not implied to be an exact version of any other system, nor do we claim any endorsement by the doctor.



AGILITY ceramic Type MBT*

AGILITY CERAMIC Type MBT Sold in packages of 5

MAXILLARY MBT² Rx

Tooth	Torque	Angle	Rotation	M/D	R/L	ID	.018	.022
Central	17°	4°	0°	3.9 mm	R	●	128-U1-8R-V	128-U1-2R-V
					L	●	128-U1-8L-V 1	28-U1-2L-V
Lateral	10°	8°	0°	3.3 mm	R	○	128-U2-8R-V	128-U2-2R-V
					L	○	128-U2-8L-V	128-U2-2L-V
Cuspid (without Hook)	-7°	8°	0°	3.4 mm	R	●	128-U3-8R-V	128-U3-2R-V
					L	●	128-U3-8L-V	128-U3-2L-V
Cuspid Hk (with Hook)	-7°	8°	0°	3.4 mm	R	●	128-U3-8RK-V	128-U3-2RK-V
					L	●	128-U3-8LK-V	128-U3-2LK-V
Cuspid (without Hook)	0°	8°	0°	3.4 mm	R	●	128-U3-8R0-V	128-U3-2R0-V
					L	●	128-U3-8L0-V	128-U3-2L0-V
Cuspid Hk (with Hook)	0°	8°	0°	3.4 mm	R	●	128-U3-8RK0-V	128-U3-2RK0-V
					L	●	128-U3-8LK0-V	128-U3-2LK0-V
1 st & 2 nd Bicuspid	-7°	0°	0°	3.4 mm	U	●●	128-U4-8U-V	128-U4-2U-V
1 st & 2 nd Bicuspid Hk	-7°	0°	0°	3.4 mm	R	●	128-U4-8RK-V	128-U4-2RK-V
					L	●	128-U4-8LK-V	128-U4-2LK-V

MANDIBULAR MBT² Rx

Tooth	Torque	Angle	Rotation	M/D	R/L	ID	.018	.022
128-L1-2U-V	Anterior	-6°	0°	0°	2.6 mm	U	●●	128-L1-8U-V
Cuspid (without Hook)	-6°	3°	0°	3.4 mm	R	●	128-L3-8R-V	128-L3-2R-V
					L	●	128-L3-8L-V	128-L3-2L-V
Cuspid Hk (with Hook)	-6°	3°	0°	3.4 mm	R	●	128-L3-8RK-V	128-L3-2RK-V
					L	●	128-L3-8LK-V	128-L3-2LK-V
Cuspid (without Hook)	0°	3°	0°	3.4 mm	R	●	128-L3-8R0-V	128-L3-2R0-V
					L	●	128-L3-8L0-V	128-L3-2L0-V
Cuspid Hk (with Hook)	0°	3°	0°	3.4 mm	R	●	128-L3-8RK0-V	128-L3-2RK0-V
					L	●	128-L3-8LK0-V	128-L3-2LK0-V
1 st Bicuspid	-12°	0°	0°	3.4 mm	U	●●	128-L4-8U-V	128-L4-2U-V
1 st Bicuspid Hk	-12°	0°	0°	3.4 mm	R	●	128-L4-8RK-V	128-L4-2RK-V
					L	●	128-L4-8LK-V	128-L4-2LK-V
2 nd Bicuspid	-17°	0°	0°	3.4 mm	U	●●	128-L5-8U-V	128-L5-2U-V
2 nd Bicuspid Hk	-17°	0°	0°	3.4 mm	R	●	128-L5-8RK-V	128-L5-2RK-V
					L	●	128-L5-8LK-V 1	28-L5-2LK-V

BRACKET KITS MBT² Rx

20 brackets per kit	.018	.022
Upper/Lower 5x5 Hook on 3	21K-3-18-01	21K-3-22-011
Upper/Lower 5x5 Hook on 3, 4, & 5	21K-345-18-01	21K-345-22-01

MBT Rx kits include 0° torque on the cuspids - custom kits available upon request.

Brackets are packaged with 1 case oriented in a kit box.

Brackets are also available in kits of 5 or 10 cases oriented in a carousel dispenser.



Agility™ Twin Bracket
kit, 20 brackets
oriented in a kit box





**Kleef- & Weldable tubes/
Tubes à coller & à souder**
TUBES



SELF-LIGATING Tubes



Experience Self-ligating tubes

MAXILLARY

Tooth 6 & 7	Torque	Angulation	Rotation	.018"		.022"	
				R	L	R	L
Experience SL tube, Roth	-10°	0°	14°D	20-1160-0010	20-1260-0010	20-2160-0010	20-2260-0010
Experience SL tube, Small Base Roth	-10°	0°	14°D	-	-	20-2160-S010	20-2260-S010
Experience SL tube, MBT	-14°	0°	10°D	20-1160-0020	20-1260-0020	20-2160-0020	20-2260-0020
Experience SL tube, Small Base MBT	-14°	0°	10°D	20-1160-S020	20-1260-S020	20-2160-S020	20-2260-S020
Experience double SL tube, Extra Torque	-20°	0°	20°D	20-1160-0030	20-1260-0030	20-2160-0030	20-2260-0030

MANDIBULAR

Tooth 6 & 7	Torque	Angulation	Rotation	.018"		.022"	
				R	L	R	L
Experience SL tube, Roth	-25°	0°	4°D	20-1460-0010	20-1360-0010	20-2460-0010	20-2360-0010
Experience SL tube, Small Base Roth	-25°	0°	4°D	-	-	20-2460-S010	20-2360-S010
Experience SL tube, MBT	-20°	0°	0°D	20-1460-0020	20-1360-0020	20-2460-0020	20-2360-0020
Experience SL tube, Small Base MBT	-20°	0°	0°D	20-1460-S020	20-1360-S020	20-2460-S020	20-2360-S020
Experience SL tube, Extra Torque	-14°	0°	4°D	-	-	20-2460-0032	20-2360-0032

MANDIBULAR

Tooth 6 & 7	Torque	Angulation	Rotation	.018"		.022"	
				R	L	R	L
Experience DOUBLE SL tube, Extra Torque	-10°	0°	4°D	20-1460-0030	20-1360-0030	20-2460-0030	20-2360-0030

De tubes zijn verpakt per 10 stuks/ Les tubes sont emballés par 10 pcs



LEGEND LP Tubes

Conventional tubes

Tooth	Torque	Angulation	Rotation	.018"		.022"	
				R	L	R	L
U6 , Roth	-14°	0°	14°	40-1160-0114	40-1260-0114	40-2160-0114	40-2260-0114
U7, Roth	-14°	0°	14°	40-1170-0114	40-1270-0114	40-2170-0114	40-2270-0114
L6, Roth	-25°	0°	4°	40-1460-0114	40-1360-0114	40-2460-0114	40-2360-0114
L7, Roth	-25°	0°	6°	40-1470-0114	40-1370-0114	40-2470-0114	40-2370-0114
U6 , MBT	-14°	0°	10°	40-1160-0106	40-1260-0106	40-2160-0106	40-2260-0106
U6 , MBT	-14°	0°	0°	40-1160-0107	40-1260-0107	40-2160-0107	40-2260-0107
U7, MBT	-14°	0°	10°	40-1170-0106	40-1270-0106	40-2170-0106	40-2270-0106
U7, MBT	-14°	0°	0°	40-1170-0107	40-1270-0107	40-2170-0107	40-2270-0107
L6, MBT	-20°	0°	0°	40-1460-0106	40-1360-0106	40-2460-0106	40-2360-0106
L7, MBT	-10°	0°	0°	40-1470-0106	40-1370-0106	40-2470-0106	40-2370-0106

De tubes zijn verpakt per 10 stuks/ Les tubes sont emballés par 10 pcs

Kleef- & Weldable TUBES à coller & à souder



LEGEND LE Tubes



LEGEND LE Tubes (Large Entrance)

Second Molar Bondable

Non-convertible single tubes for second molars, the funnel entry of these tubes facilitates access to second molars and its anatomical base fits the teeth perfectly making positioning easy.

MAXILLARY

Type Roth

Dimensions	Torque	Rotation	P/N	
			R	L
.018"x.025"	-14°	14°D	40-1170-0099	40-1270-0099
.022"x.028"	-14°	14°D	40-2170-0099	40-2270-0099

Type Andrews

Dimensions	Torque	Rotation	P/N	
			R	L
.018"x.025"	-9°	7°D	40-1170-0100	40-1270-0100
.022"x.028"	-9°	7°D	40-2170-0100	40-2270-0100

MANDIBULAR

Type Roth

Dimensions	Torque	Rotation	P/N	
			R	L
.018"x.025"	-30°	6°D	40-1470-0099	40-1370-0099
.022"x.028"	-30°	6°D	40-2470-0099	40-2370-0099

Type Andrews

Dimensions	Torque	Rotation	P/N	
			R	L
.018"x.025"	-25°	0°	40-1470-0100	40-1370-0100
.022"x.028"	-25°	0°	40-2470-0100	40-2370-0100

Type MBT*

Dimensions	Torque	Rotation	P/N	
			R	L
.018"x.025"	-10°	0°	40-1470-0101	40-1370-0101
.022"x.028"	-10°	0°	40-2470-0101	40-2370-0101

De tubes zijn verpakt per 10 stuks/ Les tubes sont emballés par 10 pcs

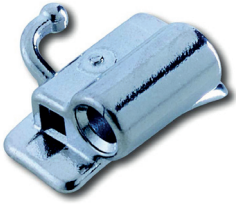

AXCESS Tubes



AXCESS Tubes

These entry point buccal tubes are manufactured in one-piece using MIM (Metal Injection Molded) technology. AXCESS tubes are available in bondable and weldable versions.

MAXILLARY

Double Non-Convertible HG .045" 1st Molar

Dimensions	Torque	Rotation	R/L	P/N	
				Weldable	Bondable
.018"x.025"	-10°	6°D	R	41-1160-0023	—
			L	41-1260-0023	—
.022"x.028"	-10°	6°D	R	41-2160-0023	—
			L	41-2260-0023	—
.018"x.025"	0°	6°D	R	41-1160-0024	—
			L	41-1260-0024	—
.022"x.028"	0°	6°D	R	41-2160-0024	—
			L	41-2260-0024	—

Single Non-Convertible 1st Molar

Dimensions	Torque	Rotation	R/L	P/N	
				Weldable	Bondable
.022"x.028"	-10°	6°D	R	41-2160-0025	40-2160-0025
			L	41-2260-0025	40-2260-0025
.018"x.025"	0°	6°D	R	41-1160-0026	40-1160-0026
			L	41-1260-0026	40-1260-0026
.022"x.028"	0°	6°D	R	—	40-2160-0026
			L	—	40-2260-0026

Single Non-Convertible 2nd Molar

Dimensions	Torque	Rotation	R/L	P/N	
				Weldable	Bondable
.018"x.025"	-10°	6°D	R	—	40-1170-0088
			L	—	40-1270-0088
.018"x.025"	0°	0°	R	—	40-1170-0090
			L	—	40-1270-0090
.018"x.025"	-10°	0°	R	—	40-1170-0091
			L	—	40-1270-0091

De tubes zijn verpakt per 10 stuks/ Les tubes sont emballés par 10 pcs



AXCESS Tubes



AXCESS Tubes

Single Non-Convertible 2nd Molar

Dimensions	Torque	Rotation	R/L	P/N	
				Weldable	Bondable
.022"x.028"	-10°	6°D	R	41-2170-0025	40-2170-0025
			L	41-2270-0025	40-2270-0025
.022"x.028"	-10°	6°D	R	—	40-2170-0088
			L	—	40-2270-0088
.022"x.028"	0°	0°	R	—	40-2170-0090
			L	—	40-2270-0090
.022"x.028"	-10°	0°	R	—	40-2170-0091
			L	—	40-2270-0091

MANDIBULAR

Single Non-Convertible 1st Molar

Dimensions	Torque	Rotation	R/L	P/N	
				Weldable	Bondable
.022"x.028"	-25°	6°D	R	41-2460-0025	40-2460-0025
			L	41-2360-0025	40-2360-0025
.018"x.025"	-25°	6°D	R	41-1460-0025	-
			L	41-1360-0025	-
.022"x.028"	0°	6°D	R	41-2460-0026	40-2460-0026
			L	41-2360-0026	40-2360-0026
.018"x.025"	0°	6°D	R	41-1460-0026	40-1460-0026
			L	41-1360-0026	40-1360-0026

Single Non-Convertible 2nd Molar

Dimensions	Torque	Rotation	R/L	P/N	
				Weldable	Bondable
.018"x.025"	0°	0°	R	—	40-1470-0090
			L	—	40-1370-0090
.018"x.025"	-25°	0°	R	—	40-1470-0091
			L	—	40-1370-0091
.022"x.028"	-25°	6°D	R	41-2470-0025	40-2470-0025
			L	41-2370-0025	40-2370-0025
.022"x.028"	-25°	6°D	R	—	40-2470-0089
			L	—	40-2370-0089
.022"x.028"	0°	0°	R	—	40-2470-0090
			L	—	40-2370-0090
.022"x.028"	-25°	6°D	R	—	40-2470-0091
			L	—	40-2370-0091

De tubes zijn verpakt per 10 stuks/ Les tubes sont emballés par 10 pcs



Maxillary Single Tubes Convertible



Type Roth, 1st Molar

						P/N	
Dimensions	Torque	Rotation	Length mm	R/L	Weldable	Bondable	
.018"x.025"	-14°	14°D	4.0	R	41-1160-0061	40-1160-0061	
				L	41-1260-0061	40-1260-0061	
.022"x.028"	-14°	14°D	4.0	R	41-2160-0061	40-2160-0061	
				L	41-2260-0061	40-2260-0061	



Type Roth, 1st Molar

						P/N	
Dimensions	Torque	Rotation	Length mm	R/L	Weldable	Bondable	
.018"x.025"	-10°	14°D	4.0	R	41-1160-0012	40-1160-0012	
				L	41-1260-0012	40-1260-0012	
.022"x.028"	-10°	14°D	4.0	R	41-2160-0012	40-2160-0012	
				L	41-2260-0012	40-2260-0012	



Type MBT*, 1st Molar

						P/N	
Dimensions	Torque	Rotation	Length mm	R/L	Weldable	Bondable	
.018"x.025"	-14°	10°D	3.8	R	41-1160-0022	40-1160-0022	
				L	41-1260-0022	40-1260-0022	
.022"x.028"	-14°	10°D	3.8	R	41-2160-0022	40-2160-0022	
				L	41-2260-0022	40-2260-0022	



Type MBT*, 1st Molar

						P/N	
Dimensions	Torque	Rotation	Length mm	R/L	Weldable	Bondable	
.018"x.025"	-14°	10°D	3.8	R	41-1160-0110	40-1160-0110	
				L	41-1260-0110	40-1260-0110	
.022"x.028"	-14°	10°D	3.8	R	41-2160-0110	40-2160-0110	
				L	41-2260-0110	40-2260-0110	



Type Andrews, 1st Molar

						P/N	
Dimensions	Torque	Rotation	Length mm	R/L	Weldable	Bondable	
.018"x.025"	-10°	7°D	3.6	R	41-1160-0034	40-1160-0034	
				L	41-1260-0034	40-1260-0034	
.022"x.028"	-10°	7°D	3.6	R	41-2160-0034	40-2160-0034	
				L	41-2260-0034	40-2260-0034	

De tubes zijn verpakt per 10 stuks/ Les tubes sont emballés par 10 pcs



Maxillary Single Tubes Non-Convertible



GET 1st Molar



Dimensions	Torque	Rotation	Length mm	R/L	P/N	
					Weldable	Bondable
.022"x.028"	-20°	10°D	4.0	R	—	40-2160-0510
				L	—	40-2260-0510
.022"x.028"	-20°	0°	4.0	R	—	40-2160-0511
				L	—	40-2260-0511



GET 2nd Molar



Dimensions	Torque	Rotation	Length mm	R/L	P/N	
					Weldable	Bondable
.022"x.028"	-20°	0°	4.0	R	—	40-2170-0120
				L	—	40-2270-0120



Type Roth Distal Extension, 2nd Molar

Dimensions	Torque	Rotation	Length mm	R/L	P/N	
					Weldable	Bondable
.018"x.025"	-14°	14°D	4.0	R	—	40-1170-0013
				L	—	40-1270-0013
.022"x.028"	-14°	14°D	4.0	R	—	40-2170-0013
				L	—	40-2270-0013



Type Roth Distal Extension, 2nd Molar

Dimensions	Torque	Rotation	Length mm	R/L	P/N	
					Weldable	Bondable
.022"x.028"	-10°	14°D	3.0	R	41-2170-0039	40-2170-0039
				L	41-2270-0039	40-2270-0039



Type Roth, 2nd Molar

Dimensions	Torque	Rotation	Length mm	R/L	P/N	
					Weldable	Bondable
.018"x.025"	-14°	14°D	4.2	R	—	40-1170-0014
				L	—	40-1270-0014
.022"x.028"	-14°	14°D	4.2	R	41-2170-0014	40-2170-0014
				L	41-2270-0014	40-2270-0014

De tubes zijn verpakt per 10 stuks/ Les tubes sont emballés par 10 pcs



Maxillary Single Tubes Non-Convertible



Type Roth, 2nd Molar

Dimensions	Torque	Rotation	Length mm	R/L	P/N	
					Weldable	Bondable
.018"x.025"	-14°	0°	4.0	R	—	40-1170-0063
				L	—	40-1270-0063
.022"x.028"	-14°	0°	4.0	R	41-2170-0063	40-2170-0063
				L	41-2270-0063	40-2270-0063

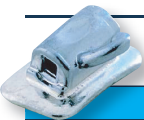

Type Roth, 2nd Molar

Dimensions	Torque	Rotation	Length mm	R/L	P/N	
					Weldable	Bondable
.018"x.025"	-14°	14°D	4.0	R	41-1170-0012	40-1170-0012
				L	41-1270-0012	40-1270-0012
.022"x.028"	-14°	14°D	4.0	R	41-2170-0012	40-2170-0012
				L	41-2270-0012	40-2270-0012



Type MBT*, 2nd Molar

Dimensions	Torque	Rotation	Length mm	R/L	P/N	
					Weldable	Bondable
.018"x.025"	-14°	10°D	4.2	R	41-1170-0022	40-1170-0022
				L	41-1270-0022	40-1270-0022
.022"x.028"	-14°	10°D	4.2	R	41-2170-0022	40-2170-0022
				L	41-2270-0022	40-2270-0022



Type Alexander Distal Extension, 2nd Molar

Dimensions	Torque	Rotation	Length mm	R/L	P/N	
					Weldable	Bondable
.022"x.028"	-10°	7°D	4.0	R	41-2170-0075	—
				L	41-2270-0075	—



Type Andrews, 2nd Molar

Dimensions	Torque	Rotation	Length mm	R/L	P/N	
					Weldable	Bondable
.018"x.025"	-10°	7°D	4.0	R	41-1170-0034	40-1170-0034
				L	41-1270-0034	40-1270-0034
.022"x.028"	-10°	7°D	4.0	R	41-2170-0034	40-2170-0034
				L	41-2270-0034	40-2270-0034

De tubes zijn verpakt per 10 stuks/ Les tubes sont emballés par 10 pcs



Type Andrews, 2nd Molar

Dimensions	Torque	Rotation	Length mm	R/L	P/N	
					Weldable	Bondable
.018"x.025"	-10°	7°D	3.0	R	41-1170-0048	40-1170-0048
				L	41-1270-0048	40-1270-0048
.022"x.028"	-10°	7°D	3.0	R	41-2170-0048	40-2170-0048
				L	41-2270-0048	40-2270-0048

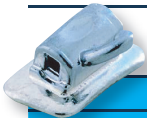

Type Andrews Wide Base, 2nd Molar

Dimensions	Torque	Rotation	Length mm	R/L	P/N	
					Weldable	Bondable
.018"x.025"	-10°	7°D	3.0	R	—	40-1170-0049
				L	—	40-1270-0049
.022"x.028"	-10°	7°D	3.0	R	—	40-2170-0049
				L	—	40-2270-0049



Type Andrews Wide Entry, 2nd Molar

Dimensions	Torque	Rotation	Length mm	R/L	P/N	
					Weldable	Bondable
.018"x.025"	-10°	7°D	3.5	R	41-1170-0018	40-1170-0018
				L	41-1270-0018	40-1270-0018
.022"x.028"	-10°	7°D	3.5	R	41-2170-0018	40-2170-0018
				L	41-2270-0018	40-2270-0018



Type Planché, 2nd Molar

Dimensions	Torque	Rotation	Length mm	R/L	P/N	
					Weldable	Bondable
.022"x.028" -	20°	14°D	4.2	R	41-2170-0071	—
				L	41-2270-0071	—

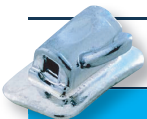

Type Polar, 2nd Molar

Dimensions	Torque	Rotation	Length mm	R/L	P/N	
					Weldable	Bondable
.018"x.025"	-25°	6°D	4.0	R	—	40-1170-0029
				L	—	40-1270-0029



Mini Eruption Tube, 2nd Molar

Dimensions	Torque	Rotation	Length mm	R/L	P/N	
					Without hook	With hook
.018"x.025"	-10°	0°D	2.0	R	40-1170-0112	40-1170-0019
				L	40-1270-0112	40-1270-0019
.022"x.028"	-10°	0°D	2.0	R	40-2170-0112	40-2170-0019
				L	40-2270-0112	40-2270-0019

De tubes zijn verpakt per 10 stuks/ Les tubes sont emballés par 10 pcs



Maxillary Double Tubes 1st Molar Convertible



Type Roth Convertible No HG

Dimensions	Torque	Rotation Slot & Aux.	R/L	P/N	
				Weldable	Bondable
.018"x.025" / .018"x.025"	-14°	14°D	R	41-1160-0011	40-1160-0011
			L	41-1260-0011	40-1260-0011
.022"x.028" / .018"x.025"	-14°	14°D	R	41-2160-0011	40-2160-0011
			L	41-2260-0011	40-2260-0011



Type Roth Convertible No HG

Dimensions	Torque	Rotation Slot	R/L	P/N	
				Weldable	Bondable
.018"x.025" / .018"x.025"	-14°	14°D	R	41-1160-0055	40-1160-0055
			L	41-1260-0055	40-1260-0055
.022"x.028" / .022"x.028"	-14°	14°D	R	41-2160-0055	40-2160-0055
			L	41-2260-0055	40-2260-0055



Type MBT* Convertible No HG

Dimensions	Torque	Rotation Slot	R/L	P/N	
				Weldable	Bondable
.018"x.025"	-14°	10°D	R	41-1160-0104	40-1160-0104
			L	41-1260-0104	40-1260-0104
.022"x.028"	-14°	10°D	R	41-2160-0104	40-2160-0104
			L	41-2260-0104	40-2260-0104



Type MBT* Convertible No HG

Dimensions	Torque	Rotation Slot	R/L	P/N	
				Weldable	Bondable
.018"x.025"	-14°	0°D	R	41-1160-0105	40-1160-0105
			L	41-1260-0105	40-1260-0105
.022"x.028"	-14°	0°D	R	41-2160-0105	40-2160-0105
			L	41-2260-0105	40-2260-0105

De tubes zijn verpakt per 10 stuks/ Les tubes sont emballés par 10 pcs



Extra Torque Convertible No HG

Dimensions	Torque	Rotation Slot	R/L	P/N	
				Weldable	Bondable
.022"x.028"	-20°	20°D	R	41-2160-0030	-
			L	41-2260-0030	-



Type Roth Convertible - HG .045"/Gingival with HG

Dimensions	Torque	Rotation Slot	Rotation HG	R/L	P/N	
					Weldable	Bondable
.018"x.025"	-14°	14°D	14°D	R	41-1160-0054	—
				L	41-1260-0054	—
.022"x.028"	-14°	14°D	14°D	R	41-2160-0054	—
				L	41-2260-0054	—



Type MBT* Convertible - HG .045"/Occlusal With HG

Dimensions	Torque	Rotation Slot	Rotation HG	R/L	P/N	
					Weldable	Bondable
.018"x.025"	-14°	10°D	0°	R	41-1160-0021	—
				L	41-1260-0021	—
.022"x.028"	-14°	10°D	0°	R	41-2160-0021	—
				L	41-2260-0021	—



Type MBT* Convertible - HG .045"/Gingival With HG

Dimensions	Torque	Rotation Slot	Rotation HG	R/L	P/N	
					Weldable	Bondable
.022"x.028"	-14°	10°D	10°D	R	41-2160-0020	-
				L	41-2260-0020	-

De tubes zijn verpakt per 10 stuks/ Les tubes sont emballés par 10 pcs



Maxillary Double Tubes 1st Molar



Type BiDimensional HG Convertible .051"/Occlusal

Dimensions	Torque	Rotation Slot	Rotation HG	R/L	P/N	
					Weldable	Bondable
.022"x.028"	0°	6°D	0°	R	41-2160-0080	—
				L	41-2260-0080	—



Type BiDimensional HG Convertible .051"/Occlusal

Dimensions	Torque	Rotation Slot	Rotation HG	R/L	P/N	
					Weldable	Bondable
.022"x.028"	0°	14°D	7°D	R	41-2160-0083	—
				L	41-2260-0083	—



Type Alexander Convertible - HG .045"/Occlusal

Dimensions	Torque	Rotation Slot	Rotation HG	R/L	P/N	
					Weldable	Bondable
.018"x.025"	-10°	14°D	7°D	R	41-1160-0073	—
				L	41-1260-0073	—
.022"x.028"	-10°	14°D	7°D	R	41-2160-0073	—
				L	41-2260-0073	—



Type Andrews Convertible - HG .045"/Occlusal

Dimensions	Torque	Rotation Slot	Rotation HG	R/L	P/N	
					Weldable	Bondable
.018"x.025"	-10°	7°	7°D	R	41-1160-0079	40-1160-0079
				L	41-1260-0079	40-1260-0079
.022"x.028"	-10°	7°	7°D	R	41-2160-0079	40-2160-0079
				L	41-2260-0079	40-2260-0079

De tubes zijn verpakt per 10 stuks/ Les tubes sont emballés par 10 pcs



Type Andrews Convertible - HG .051\"/>

Dimensions	Torque	Rotation Slot	Rotation HG	R/L	P/N	
					Weldable	Bondable
.022\"x.028\"	-10°	6°	0°	R	41-2160-0087	—
				L	41-2260-0087	—



Type Andrews Convertible - HG .045\"/>

Dimensions	Torque	Rotation Slot	Rotation HG	R/L	P/N	
					Weldable	Bondable
.018\"x.025\"	-10°	7°D	7°D	R	41-1160-0033	—
				L	41-1260-0033	—
.022\"x.028\"	-10°	7°D	7°D	R	41-2160-0033	—
				L	41-2260-0033	—



Type Andrews Non-Convertible - HG .045\"/>

Dimensions	Torque	Rotation Slot	Rotation HG	R/L	P/N	
					Weldable	Bondable
.018\"x.025\"	-10°	6°D	0°	R	41-1160-0086	—
				L	41-1260-0086	—
.022\"x.028\"	-10°	6°D	0°	R	41-2160-0086	—
				L	41-2260-0086	—



Edgewise Convertible - HG .045\"/>

Dimensions	Torque	Rotation Slot	Rotation HG	R/L	P/N	
					Weldable	Bondable
.018\"x.025\"	0°	0°	0°	R	41-1160-0077	—
				L	41-1260-0077	—
.022\"x.028\"	0°	0°	0°	R	41-2160-0077	—
				L	41-2260-0077	—



Edgewise Non-Convertible - HG .045\"/>

Dimensions	Torque	Rotation Slot	Rotation HG	R/L	P/N	
					Weldable	Bondable
.018\"x.025\"	0°	0°	0°	R	41-1160-0084	—
				L	41-1260-0084	—
.022\"x.028\"	0°	0°	0°	R	41-2160-0084	—
				L	41-2260-0084	—

De tubes zijn verpakt per 10 stuks/ Les tubes sont emballés par 10 pcs



Maxillary Double Tubes 1st Molar



Edgewise Convertible - HG .045"/Occlusal

Dimensions	Torque	Rotation Slot	Rotation HG	R/L	P/N	
					Weldable	Bondable
.018"x.025"	0°	6°D	6°D	R	41-1160-0081	—
				L	41-1260-0081	—
.022"x.028"	0°	6°D	6°D	R	41-2160-0081	—
				L	41-2260-0081	—



Edgewise Non-Convertible - HG .045"/Occlusal

Dimensions	Torque	Rotation Slot	Rotation HG	R/L	P/N	
					Weldable	Bondable
.022"x.028"	0°	6°D	0°	R	41-2160-0085	—
				L	41-2260-0085	—



Type Planché Convertible - HG .045"/Gingival

Dimensions	Torque	Rotation Slot	Rotation HG	R/L	P/N	
					Weldable	Bondable
.022"x.028"	-14°	14°D	0°	R	41-2160-0070	—
				L	41-2260-0070	—

De tubes zijn verpakt per 10 stuks/ Les tubes sont emballés par 10 pcs



Maxillary Triple Tubes 1st Molar



MAXILLARY Triple Tubes 1st Molar
GET HG .045"/Occlusal



						P/N	
Dimensions	Torque	Rotation Slot	Rotation HG	R/L	Weldable	Bondable	
.022"x.028"	-20°	10°D	0°	R	41-2160-0500	—	
				L	41-2260-0500	—	
.022"x.028"	-20°	0°	0°	R	41-2160-0501	—	
				L	41-2260-0501	—	



Type Roth Convertible - HG .045"/Occlusal

						P/N	
Dimensions	Torque	Rotation Slot	Rotation HG	R/L	Weldable	Bondable	
.018"x.025"/ .018"x.025"	-14°	14°D	14°D	R	41-1160-0010	—	
				L	41-1260-0010	—	
.022"x.028"/ .018"x.025"	-14°	14°D	14°D	R	41-2160-0010	—	
				L	41-2260-0010	—	



Type Roth Convertible - HG .045"/Occlusal

						P/N	
Dimensions	Torque	Rotation Slot	Rotation HG	R/L	Weldable	Bondable	
.022"x.028"/ .022"x.028"	-14°	14°D	14°D	R	41-2160-0050	—	
				L	41-2260-0050	—	



Type Roth Convertible - HG .045"/Occlusal

						P/N	
Dimensions	Torque	Rotation Slot	Rotation HG	R/L	Weldable	Bondable	
.018"x.025"	-14°	0°	0°	R	41-1160-0051	—	
				L	41-1260-0051	—	
.022"x.028"	-14°	0°	0°	R	41-2160-0051	—	
				L	41-2260-0051	—	



Type Roth Convertible - HG .051"/Occlusal

						P/N	
Dimensions	Torque	Rotation Slot	Rotation HG	R/L	Weldable	Bondable	
.022"x.028"	-14°	14°D	14°D	R	41-2160-0052	—	
				L	41-2260-0052	—	

De tubes zijn verpakt per 10 stuks/ Les tubes sont emballés par 10 pcs



Maxillary Triple Tubes 1st Molar



Type Roth Convertible - HG .051"/Occlusal

Dimensions	Torque	Rotation Slot	Rotation HG	R/L	P/N	
					Weldable	Bondable
.022"x.028"	-14°	0°	0°	R	41-2160-0053	—
				L	41-2260-0053	—



Type MBT* Convertible F.E.O. .045"/Occlusal

Dimensions	Torque	Rotation Slot	Slot aux.	R/L	P/N	
					Weldable	Bondable
.018"x.025"	-14°	10°	.018"x.025"	R	41-1160-0111	—
				L	41-1260-0111	—
.022"x.028"	-14°	10°	.018"x.025"	R	41-2160-0111	—
				L	41-2260-0111	—



Type Bio-Progressive Convertible - HG .045"/Gingival

Dimensions	Torque	Rotation Slot	Rotation HG	R/L	P/N	
					Weldable	Bondable
.018"x.025"	0°	15°D	15°D	R	41-1160-0042	—
				L	41-1260-0042	—



Type Bio-Progressive Convertible - HG .045"/Gingival

Dimensions	Torque	Rotation Slot	Rotation HG	R/L	P/N	
					Weldable	Bondable
.018"x.025"	0°	0°	0°	R	41-1160-0041	—
				L	41-1260-0041	—
.022"x.028"	0°	0°	0°	R	41-2160-0041	—
				L	41-2260-0041	—



Type Bio-Progressive Non-Convertible - HG .045"/Occlusal

Dimensions	Torque	Rotation Slot	Rotation HG	R/L	P/N	
					Weldable	Bondable
.018"x.025"	0°	0°	0°	R	41-1160-0040	—
				L	41-1260-0040	—
.022"x.028"	0°	0°	0°	R	41-2160-0040	—
				L	41-2260-0040	—

De tubes zijn verpakt per 10 stuks/ Les tubes sont emballés par 10 pcs

Edgewise Convertible - HG .045"/Occlusal

Dimensions	Torque	Rotation Slot	Rotation HG	R/L	P/N	
					Weldable	Bondable
.018"x.025"	0°	6°D	0°	R	41-1160-0065	—
				L	41-1260-0065	—
.022"x.028"	0°	6°D	0°	R	41-2160-0065	—
				L	41-2260-0065	—

Type Polar Convertible - HG .045"/Gingival

Dimensions	Torque	Rotation Slot	Rotation HG	R/L	P/N	
					Weldable	Bondable
.018"x.025"	-20°	10°D	0°	R	41-1160-0027	—
				L	41-1260-0027	—

Type Hilgers Convertible - HG .045"/Occlusal

Dimensions	Torque	Rotation Slot	Rotation HG	R/L	P/N	
					Weldable	Bondable
.018"x.025"	-10°	15°D	0°	R	41-1160-0046	—
				L	41-1260-0046	—
.022"x.028"	-10°	15°D	0°	R	41-2160-0046	—
				L	41-2260-0046	—

Type Melsen Convertible - HG .045"/Occlusal

Dimensions	Torque	Rotation Slot	Rotation HG	R/L	P/N	
					Weldable	Bondable
.018"x.025"	-10°	8°D	0°	R	41-1160-0068	—
				L	41-1260-0068	—
.022"x.028"	-10°	8°D	0°	R	41-2160-0068	—
				L	41-2260-0068	—

De tubes zijn verpakt per 10 stuks/ Les tubes sont emballés par 10 pcs



Mandibular Single Tubes 1st Molar



Convertible



Type Roth

Dimensions	Torque	Angulation	Rotation	Length mm	R/L	P/N	
						Weldable	Bondable
.018"x.025"	-25°	0°	4°D	4.0	R	41-1460-0012	40-1460-0012
					L	41-1360-0012	40-1360-0012
.018"x.025"	-30°	0°	4°D	4.0	R	41-1460-0062	40-1460-0062
					L	41-1360-0062	40-1360-0062
.022"x.028"	-25°	0°	4°D	4.0	R	41-2460-0012	40-2460-0012
					L	41-2360-0012	40-2360-0012
.022"x.028"	-30°	0°	4°D	4.0	R	41-2460-0062	40-2460-0062
					L	41-2360-0062	40-2360-0062



Type MBT*

Dimensions	Torque	Angulation	Rotation	Length mm	R/L	P/N	
						Weldable	Bondable
.018"x.025"	-20°	0°	0°	3.8	R	41-1460-0022	40-1460-0119
					L	41-1360-0022	40-1360-0119
.018"x.025"	-10°	0°	0°	4.0	R	41-1460-0076	40-1460-0076
					L	41-1360-0076	40-1360-0076
.022"x.028"	-20°	0°	0°	3.8	R	41-2460-0119	40-2460-0119
					L	41-2360-0119	40-2360-0119
.022"x.028"	-10°	0°	0°	4.0	R	41-2460-0076	40-2460-0076
					L	41-2360-0076	40-2360-0076



Type Alexander

Dimensions	Torque	Angulation	Rotation	Length mm	R/L	P/N	
						Weldable	Bondable
.018"x.025"	-22°	-6°	5°D	3.8	R	41-1460-0074	—
					L	41-1360-0074	—



Type Andrews

Dimensions	Torque	Angulation	Rotation	Length mm	R/L	P/N	
						Weldable	Bondable
.018"x.025"	-25°	0°	0°	3.6	R	41-1460-0034	40-1460-0034
					L	41-1360-0034	40-1360-0034
.022"x.028"	-25°	0°	0°	3.6	R	41-2460-0034	40-2460-0034
					L	41-2360-0034	40-2360-0034

De tubes zijn verpakt per 10 stuks/ Les tubes sont emballés par 10 pcs

Convertible



Type Planché

Dimensions	Torque	Angulation	Rotation	Length mm	R/L	P/N	
						Weldable	Bondable
.022"x.028"	-25°	-6°	6°D	4.0	R	41-2460-0121	—
					L	41-2360-0121	—



Edgewise

Dimensions	Torque	Angulation	Rotation	Length mm	R/L	P/N	
						Weldable	Bondable
.022"x.028"	0°	0°	6°D	4.0	R	—	40-2460-0092
					L	—	40-2360-0092



Edgewise

Dimensions	Torque	Angulation	Rotation	Length mm	R/L	P/N	
						Weldable	Bondable
.018"x.025"	0°	0°	0°	4.0	R	41-1460-0093	40-1460-0093
					L	41-1360-0093	40-1360-0093
.022"x.028"	0°	0°	0°	4.0	R	41-2460-0093	40-2460-0093
					L	41-2360-0093	40-2360-0093



Type Polar

Dimensions	Torque	Angulation	Rotation	Length mm	R/L	P/N	
						Weldable	Bondable
.018"x.025"	-22°	0°	4°D	4.0	R	—	40-2460-0029
					L	—	40-2360-0029

De tubes zijn verpakt per 10 stuks/ Les tubes sont emballés par 10 pcs



Mandibular Single Tubes 2nd Molar



Non-Convertible



Type Roth

Dimensions	Torque	Angulation	Rotation	Length mm	R/L	P/N	
						Weldable	Bondable
.018"x.025"	-25°	0°	6°D	4.0	R	41-1470-0012	40-1470-0012
					L	41-1370-0012	40-1370-0012
.022"x.028"	-25°	0°	6°D	4.0	R	41-2470-0012	40-2470-0012
					L	41-2370-0012	40-2370-0012



Type Roth

Dimensions	Torque	Angulation	Rotation	Length mm	R/L	P/N	
						Weldable	Bondable
.018"x.025"	-30°	-1°	4°D	4.0	R	41-1470-0064	40-1470-0064
					L	41-1370-0064	40-1370-0064
.022"x.028"	-30°	-1°	4°D	4.0	R	41-2470-0064	40-2470-0064
					L	41-2370-0064	40-2370-0064



Type MBT*

Dimensions	Torque	Angulation	Rotation	Length mm	R/L	P/N	
						Weldable	Bondable
.018"x.025"	-10°	0°	0°	3.2	R	41-1470-0022	40-1470-0022
					L	41-1370-0022	40-1370-0022
.022"x.028"	-10°	0°	0°	3.2	R	41-2470-0022	40-2470-0022
					L	41-2370-0022	40-2370-0022



Plan. Type

Dimensions	Torque	Angulation	Rotation	Length mm	R/L	P/N	
						Weldable	Bondable
.022"x.028"	-27°	-10°	6°D		R	41-2470-0012	—
					L	41-2370-0012	—



Alexander Type

Dimensions	Torque	Angulation	Rotation	Length mm	R/L	P/N	
						Weldable	Bondable
.022"x.028"	-27°	-10°	6°D		R	—	40-2470-0074
					L	—	40-2370-0074

De tubes zijn verpakt per 10 stuks/ Les tubes sont emballés par 10 pcs

Non-Convertible



Type Andrews

							P/N	
Dimensions	Torque	Angulation	Rotation	Length mm	R/L	Weldable	Bondable	
.018"x.025"	-25°	0°	0°	4.0	R	—	40-1470-0034	
					L	—	40-1370-0034	
.022"x.028"	-25°	0°	0°	4.0	R	—	40-2470-0034	
					L	—	40-2370-0034	
.018"x.025"	-25°	0°	4°D	3.0	R	—	40-1470-0049	
					L	—	40-1370-0049	
.022"x.028"	25°	0°	4°D	3.0	R	—	40-2470-0049	
					L	—	40-2370-0049	



Type Andrews Wide Entry (Peucat)

							P/N	
Dimensions	Torque	Angulation	Rotation	Length mm	R/L	Weldable	Bondable	
.018"x.025"	-25°	0°	4°D	3.5	R	41-1470-0018	40-1470-0018	
					L	41-1370-0018	40-1370-0018	
.022"x.028"	-25°	0°	4°D	3.5	R	41-2470-0018	40-2470-0018	
					L	41-2370-0018	40-2370-0018	



Type Polar

							P/N	
Dimensions	Torque	Angulation	Rotation	Length mm	R/L	Weldable	Bondable	
.018"x.025"	-25°	5°	7°D	4	R	—	40-1470-0029	
					L	—	40-1370-0029	



Edgewise

							P/N	
Dimensions	Torque	Angulation	Rotation	Length mm	R/L	Weldable	Bondable	
.018"x.025"	0°	0°	0°	4.6	R	—	40-1470-0094	
					L	—	40-1370-0094	
.022"x.028"	0°	0°	0°	4.6	R	41-2470-0094	40-2470-0094	
					L	41-2370-0094	40-2370-0094	

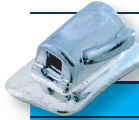

Edgewise

							P/N	
Dimensions	Torque	Angulation	Rotation	Length mm	R/L	Weldable	Bondable	
.018"x.025"	0°	0°	0°	4.0	R	41-1470-0095	40-1470-0095	
					L	41-1370-0095	40-1370-0095	
.022"x.028"	0°	0°	0°	4.0	R	41-2470-0095	40-2470-0095	
					L	41-2370-0095	40-2370-0095	

De tubes zijn verpakt per 10 stuks/ Les tubes sont emballés par 10 pcs



Mandibular Single Tubes 2nd Molar



Non-Convertible



Edgewise

Dimensions	Torque	Angulation	Rotation	Length mm	R/L	P/N	
						Weldable	Bondable
.018"x.025"	0°	0°	6°D	4.0	R	—	40-1470-0096
					L	—	40-1370-0096
.022"x.028"	0°	0°	6°D	4.0	R	41-2470-0096	40-2470-0096
					L	41-2370-0096	40-2370-0096



Edgewise

Dimensions	Torque	Angulation	Rotation	Length mm	R/L	P/N	
						Weldable	Bondable
.018"x.025"	0°	0°	6°D	3.2	R	—	40-1470-0097
					L	—	40-1370-0097
.022"x.028"	0°	0°	6°D	3.2	R	41-2470-0096	40-2470-0097
					L	41-2370-0096	40-2370-0097



Edgewise

Dimensions	Torque	Angulation	Rotation	Length mm	R/L	P/N	
						Weldable	Bondable
.018"x.025"	0°	0°	0°	3.2	R	—	40-1470-0098
					L	—	40-1370-0098
.022"x.028"	0°	0°	0°	3.2	R	41-2470-0098	40-2470-0098
					L	41-2370-0098	40-2370-0098



Small

Dimensions	Torque	Angulation	Rotation	Length mm	R/L	P/N	
						Weldable	Bondable
.018"x.025"	-25°	0°	4°D	3.0	R	—	40-1470-0048
					L	—	40-1370-0048
.022"x.028"	-25°	0°	4°D	3.0	R	—	40-2470-0048
					L	—	40-2370-0048

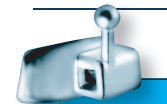

Mini Eruption Tube for 2nd Molar

Dimensions	Torque	Angulation	Rotation	Length mm	R/L	P/N	
						Without hook	With hook
.018"x.025"	-25°	0°	0°	2.0	R	40-1470-0112	40-1470-0019
					L	40-1370-0112	40-1370-0019
.022"x.028"	-25°	0°	0°	2.0	R	40-2470-0112	40-2470-0019
					L	40-2370-0112	40-2370-0019

De tubes zijn verpakt per 10 stuks/ Les tubes sont emballés par 10 pcs



Mandibular Double Tubes 1st Molar



Convertible with Tube Bumper



Type BiDimensional .051"/Gingival

Dimensions	Torque	Angulation Tube	Rotation Slot	Rotation Aux.	R/L	P/N	
						Weldable	Bondable
.022"x.028"	0°	0°	0°	0°	R	41-2460-0067	—
					L	41-2360-0067	—



Type Cetlin .045"/Gingival

Dimensions	Torque	Angulation Tube	Rotation Slot	Rotation Aux.	R/L	P/N	
						Weldable	Bondable
.018"x.025"	-25°	0°	4°D	5M	R	41-1460-0037	—
					L	41-1360-0037	—
.022"x.028"	-25°	0°	4°D	5M	R	41-2460-0037	—
					L	41-2360-0037	—

Convertible



Type Roth Convertible

Dimensions	Torque	Angulation Tube	Rotation Slot	Rotation Aux.	R/L	P/N	
						Weldable	Bondable
.018"x.025" -	25°	0°	4°D	0°	R	41-1460-0011	40-1460-0011
					L	41-1360-0011	40-1360-0011
.022"x.028"	-25°	0°	4°D	0°	R	41-2460-0011	40-2460-0011
					L	41-2360-0011	40-2360-001



Type Roth Occlusal Hook

Dimensions	Torque	Angulation Tube	Rotation Slot	Rotation Aux.	R/L	P/N	
						Weldable	Bondable
.022"x.028"	-30°	-1°	4°D	0°	R	41-2460-0058	40-2460-0058
					L	41-2360-0058	40-2360-0058

De tubes zijn verpakt per 10 stuks/ Les tubes sont emballés par 10 pcs



Mandibular Double Tubes 1st Molar



Convertible



Type Roth Gingival Hook

Dimensions	Torque	Angulation Tube	Rotation Slot	Rotation Aux.	R/L	P/N	
						Weldable	Bondable
.022"x.028"	-30°	-1°	4°D	0°	R	41-2460-0060	40-2460-0060
					L	41-2360-0060	40-2360-0060



Extra Torque

Dimensions	Torque	Angulation Tube	Rotation Slot	Rotation Aux.	R/L	P/N	
						Weldable	Bondable
.018"x.025"	-10°	0°	4°D	0°	R	41-1460-0070	—
					L	41-1360-0070	—
.022"x.028"	-10°	0°	4°D	0°	R	41-2460-0070	40-2460-0070
					L	41-2360-0070	40-2360-0070



Extra Torque Wide Base

Dimensions	Torque Slot & Aux.	Angulation Tube	Rotation Slot	Rotation Aux.	R/L	P/N	
						Weldable	Bondable
.018"x.025"	-10°	0°	4°D	0°	R	—	40-1460-0031
					L	—	40-1360-0031
.022"x.028"	-10°	0°	4°D	0°	R	—	40-2460-0031
					L	—	40-2360-0031



Type Bio-Progressive

Dimensions	Torque Slot	Torque Aux.	Rotation Slot	Rotation Aux.	R/L	P/N	
						Weldable	Bondable
.018"x.025"	0°	0°	0°	0°	UNI	41-1660-0045	40-1660-0045
.022"x.028"	0°	0°	0°	0°	UNI	41-2660-0045	40-2660-0045



Type Polar

Dimensions	Torque Slot	Torque Aux.	Rotation Slot	Rotation Aux.	R/L	P/N	
						Weldable	Bondable
.018"x.025"	-25°	0°	4°D	0°	R	41-1460-0028	—
					L	41-1360-0028	—

De tubes zijn verpakt per 10 stuks/ Les tubes sont emballés par 10 pcs

Convertible



Type Hilgers

Dimensions	Torque Slot	Torque Aux.	Rotation Slot	Rotation Aux.	R/L	P/N	
						Weldable	Bondable
.018"x.025"	-27°	0°	12°D	0°	R	41-1460-0047	—
					L	41-1360-0047	—
.022"x.028"	-27°	0°	12°D	0°	R	41-2460-0047	—
					L	41-2360-0047	—



Type Melsen

Dimensions	Torque Slot	Torque Aux.	Rotation Slot	Rotation Aux.	R/L	P/N	
						Weldable	Bondable
.018"x.025"	-27°	0°	8°D	0°	R	41-1460-0069	—
					L	41-1360-0069	—
.022"x.028"	-27°	0°	8°D	0°	R	41-2460-0069	—
					L	41-2360-0069	—

Non- Convertible



Type Roth

Dimensions	Torque	Angulation Tube	Rotation Slot	Rotation Aux.	R/L	P/N	
						Weldable	Bondable
.022"x.028"	-30°	-1°	4°D	0°	R	41-2460-0059	—
					L	41-2360-0059	—

Type Bio-Progressive



Dimensions	Torque Slot	Torque Aux.	Rotation Slot	Rotation Aux.	R/L	P/N	
						Weldable	Bondable
.018"x.025"	0°	0°	0°	0°	UNI	41-1660-0044	40-1660-0044
.022"x.028"	0°	0°	0°	0°	UNI	41-2660-0044	40-2660-0044

De tubes zijn verpakt per 10 stuks/ Les tubes sont emballés par 10 pcs



VIPER Tubes

Buccal Single Non-Convertible

VIPER™ LOW PROFILE BUCCAL TUBES

Innovative technology and sleek, stylish comfort

VIPER™ Low Profile Buccal Tubes Sleek and stylish, G&H®'s Viper™ buccal tube incorporates the latest design technology with a growing industry demand for comfortable, easy-to-use appliances that simplify treatment and reduce valuable chair time.

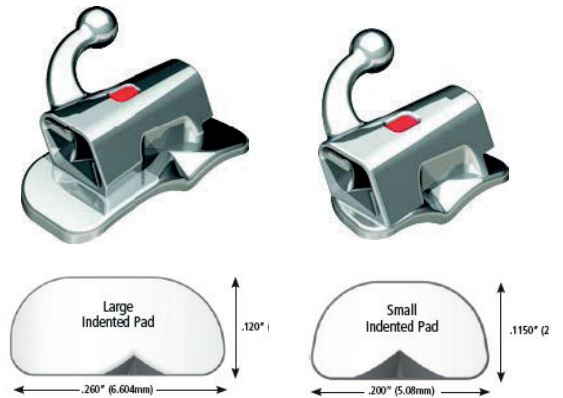

MAXILLARY 1st & 2nd Molar

Torque	Offset	Rx	M/D	R/L	ID	Bondable			
						.018	.022	.018	.022
0°	0°	STD	4.2 mm	R	◆	NS3B-821E	NS3B-221E	NS3B-821I	NS3B-221I
				L	◆	NS3B-822E	NS3B-222E	NS3B-822I	NS3B-222I
-10°	8°	Roth	4.2 mm	R	●	NS3B-825E	NS3B-225E	NS3B-825I	NS3B-225I
				L	●	NS3B-826E	NS3B-226E	NS3B-826I	NS3B-226I
-14°	10°	MBT	4.2 mm	R	●	NS3B-833E	NS3B-233E	NS3B-833I	NS3B-233I
				L	●	NS3B-834E	NS3B-234E	NS3B-834I	NS3B-234I

MANDIBULAR 1st & 2nd Molar

Torque	Offset	Rx	M/D	R/L	ID	Bondable			
						.018	.022	.018	.022
0°	0°	STD	4.2 mm	R	◆	NS3B-822E	NS3B-222E	NS3B-822I	NS3B-222I
				L	◆	NS3B-821E	NS3B-221E	NS3B-821I	NS3B-221I
-25°	5°	Roth	4.2 mm	R	■	NS3B-827E	NS3B-227E	NS3B-827I	NS3B-227I
				L	■	NS3B-828E	NS3B-228E	NS3B-828I	NS3B-228I
-20°	0°	MBT	4.2 mm	R	▲	NS3B-809E	NS3B-209E	NS3B-809I	NS3B-209I
				L	▲	NS3B-810E	NS3B-210E	NS3B-810I	NS3B-210I

De tubes zijn verpakt per 10 stuks/ Les tubes sont emballés par 10 pcs

Evolve Flow Bondable Tubes

Positioning Guide

Occlusal/gingival positioning guides ensure a secure grip and ease of placement

Distal Notch

Evolve Flow features a distal notch for ligation and tieback of auxiliaries

Contoured Base

Anatomically contoured base with occlusal indent ensures accurate fit, whilst the 80 gauge mesh pad ensures superior bond strength

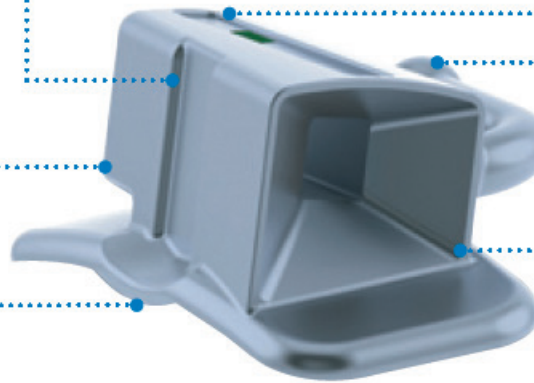

Low profile

The contoured surfaces are low profile and tapered for patient comfort

Low profile hook

Low profile hooks guarantee patient comfort and allow for easy placements of attachments

The Funnelled Entrance

The Evolve Flow funnelled entrance allows for easy wire insertion

Roth .022	1 st Molars	2 nd Molars
Upper Left	DB07-1350UL	DB07-1371UL
Upper Right	DB07-1350UR	DB07-1371UR
Lower Left	DB07-1350LL	DB07-1371LL
Lower Right	DB07-1350LR	DB07-1371LR

MBT .022	1 st Molars	2 nd Molars
Upper Left	DB07-1360UL	DB07-1372UL
Upper Right	DB07-1360UR	DB07-1372UR
Lower Left	DB07-1360LL	DB07-1372LL
Lower Right	DB07-1360LR	DB07-1372LR

Roth .018	1 st Molars	2 nd Molars
Upper Left	DB07-1370UL	DB07-1373UL
Upper Right	DB07-1370UR	DB07-1373UR
Lower Left	DB07-1370LL	DB07-1373LL
Lower Right	DB07-1370LR	DB07-1373LR

MBT .018	1 st Molars	2 nd Molars
Upper Left	DB07-1362UL	DB07-1374UL
Upper Right	DB07-1362UR	DB07-1374UR
Lower Left	DB07-1362LL	DB07-1374LL
Lower Right	DB07-1362LR	DB07-1374LR

De tubes zijn verpakt per 10 stuks/ Les tubes sont emballés par 10 pcs





Banden/Bagues



SURE-SNAP Molar Bands



Sure-Snap Molar Bands zijn gemaakt uit een speciale legering waardoor ze tegelijkertijd stevig en elastisch zijn.

Door het verschil in dikte tussen occlusale en gingivale randen zijn deze banden:

- Bestand tegen de druk van de bandpusher (occlusale rand)
- Elastisch genoeg om over de contouren van de tand te passen zonder vervorming (gingivale rand)

Sure-Snap heeft een unieke anatomische vorm voor elk type molaar, een gemakkelijk te lezen permanente identificatie en een geëlektrodeerd interieur voor een betere hechting.

Deze banden zijn verkrijgbaar in 32 maten voor de eerste molaren en 30 maten voor de tweede molaren.

Les bagues Sure-Snap sont faites d'un alliage spécial qui les rend à la fois robustes et élastiques.

En raison de la différence d'épaisseur entre les bords occlusaux et gingivaux, ces bandes sont :

- Résistant à la pression du pousse-bagues (bord occlusal)
- Suffisamment élastique pour s'adapter aux contours de la dent sans déformation (bord gingival)

La bague Sure-Snap a une forme anatomique unique pour chaque type de molaire, une identification permanente facile à lire et un intérieur électrodéposé pour une meilleure adhérence.

Ces bagues sont disponibles en 32 tailles pour la première molaire et 30 tailles pour la deuxième molaire.

Sure-Snap First Molar Kits - Verdeling banden per kwadrant/Partage des bagues par quadrant																																
Size	1	2	3	4	5	6	7	8	9	10	11	12	13	14	15	16	17	18	19	20	21	22	23	24	25	26	27	28	29	30	31	32
Starter											1	2	2	2	2	2	2	2	2	2	2	2	2	2	2	2	2	2	2	2	2	
Intro	1	1	1	1	1	1	1	1	1	1	2	2	2	2	2	3	3	3	3	2	2	2	2	2	2	1	1	1	1	1	1	1
Standard	1	1	1	1	2	2	2	3	4	4	4	5	5	6	6	6	6	6	6	5	5	4	3	2	2	2	2	1	1	1	1	1
Master	1	1	1	2	2	2	4	4	6	6	8	10	10	12	14	16	16	16	14	12	10	8	6	4	4	2	2	2	2	2	1	1

Sure-Snap Second Molar Kits - Verdeling banden per kwadrant/Partage des bagues par quadrant																															
Size	1	2	3	4	5	6	7	8	9	10	11	12	13	14	15	16	17	18	19	20	21	22	23	24	25	26	27	28	29	30	
Starter											1	2	2	2	2	2	2	2	2	2	2	2	2	2	2	2	2	2	2	2	
Intro	1	1	1	1	1	1	1	1	1	2	2	2	2	2	2	3	3	3	3	2	2	2	2	2	2	2	1	1	1	1	1
Standard	1	1	1	2	2	2	2	3	4	4	4	5	5	6	6	6	6	6	6	5	5	4	3	2	2	2	2	1	1	1	
Master	1	1	1	2	2	2	4	4	6	6	8	10	10	12	14	16	16	16	16	12	10	8	6	4	4	2	2	2	2	1	

Starter Kit: 25 banden per kwadrant/bagues par quadrant

Intro Kit: 50 banden per kwadrant/bagues par quadrant

Standard Kit: 100 banden per kwadrant/bagues par quadrant

Master Kit: 200 banden per kwadrant/bagues par quadrant





A-FIT Molar Bands



De A-Fit bands hebben alle kwaliteiten van de Sure-Snap bands.

Het verschil is een hogere kroonhoogte en een grotere keuze aan maten in de hogere aantallen. Zijn ook minder elastisch en gemakkelijk aan te passen.

Les bagues A-Fit ont toutes les qualités des bagues Sure-Snap.

La différence réside dans une hauteur de couronne plus élevée et un plus grand choix de tailles dans les chiffres les plus élevés. Sont également moins élastiques et faciles à ajuster.

A-Fit First Molar Kits - Verdeling banden per kwadrant/Partage des bagues par quadrant																																					
Size	5	6	7	8	9	10	11	12	13	14	15	16	17	18	19	20	21	22	23	24	25	26	27	28	29	30	31	32	33	34	35	36	37	38			
Starter										1	2	2	2	2	2	2	2	2	2	2	2	2	2	2	2	2	2	2	2	2	2	2	2	2	2		
Intro	1	1	1	1	1	1	2	2	2	2	2	3	3	3	2	2	2	2	2	1	1	1	1	1	1	1	1	1	1	1	1	1	1	1	1		
Standard	1	1	1	2	4	4	4	5	6	6	6	6	6	6	5	5	4	4	3	3	2	2	2	2	1	1	1	1	1	1	1	1	1	1			
Master	2	2	2	6	8	8	8	10	12	12	12	12	12	12	10	10	8	8	6	6	4	4	4	2	2	2	2	2	2	2	2	2	2	2			

A-Fit Second Molar Kits - Verdeling banden per kwadrant/Partage des bagues par quadrant																																		
Size	1	2	3	4	5	6	7	8	9	10	11	12	13	14	15	16	17	18	19	20	21	22	23	24	25	26	27	28	29	30	31	32		
Starter												1	2	2	2	2	2	2	2	2	2	2	2	2	2	2	2	2	2	2	2	2		
Intro		1	1	1	1	1	1	1	1	1	1	1	2	2	2	2	2	2	3	3	3	3	2	2	2	2	1	1	1	1	1	1	1	
Standard		1	1	1	1	2	2	2	3	4	4	4	5	5	6	6	6	6	6	6	5	5	4	3	2	2	2	2	1	1	1	1	1	1
Master		1	1	1	2	2	2	4	4	6	6	8	10	10	12	14	16	16	16	14	12	10	8	6	4	4	2	2	2	2	1	1	1	

Starter Kit: 25 banden per kwadrant/bagues par quadrant
 Intro Kit: 50 banden per kwadrant/bagues par quadrant
 Standard Kit: 100 banden per kwadrant/bagues par quadrant
 Master Kit: 200 banden per kwadrant/bagues par quadrant





SURE-SNAP Bicuspid Bands



Het plaatsen van de band gebeurt d.m.v. een schommelende beweging, waarbij de mesiale en distale druk elkaar afwisselen.

Verkrijgbaar in drie anatomische vormen:

- Eerste Maxillaire Bicuspiden (32 Maten)
- Eerste Mandibulaire Bicuspiden (25 Maten)
- Tweede Mandibulaire Bicuspiden (27 Maten)

La bague est placée au moyen d'un mouvement de balancement, dans lequel la pression mésiale et distale alternent.

Disponible en trois formes anatomiques:

- Premières prémolaires maxillaires (32 tailles)
- Premières prémolaires mandibulaires (25 tailles)
- Deuxièmes prémolaires mandibulaires (27 tailles)

Sure-Snap Upper Bicuspid Kits - Distribution

Size	1	2	3	4	5	6	7	8	9	10	11	12	13	14	15	16	17	18	19	20	21	22	23	24	25	26	27	28	29	30	31	32
Starter						2	2	2	2	2	2	2	2	2	2	4	4	4	2	2	2	2	2	2	2	2	2					
Intro	2	2	2	2	2	2	2	2	2	2	4	4	4	4	6	6	6	6	6	4	4	4	4	2	2	2	2	2	2	2	2	2
Standard	2	2	2	2	2	4	6	6	6	6	6	8	8	10	12	14	14	14	12	10	8	8	6	6	6	4	4	4	2	2	2	2
Master	4	4	4	6	6	10	10	14	14	16	16	16	18	18	20	22	22	22	20	18	16	16	14	14	12	12	8	8	8	4	4	4

Sure-Snap First Lower Bicuspid Kits - Distribution

Size	1	2	3	4	5	6	7	8	9	10	11	12	13	14	15	16	17	18	19	20	21	22	23	24	25
Starter			2	4	4	4	4	4	4	4	4	4	4	4	4										
Intro	2	2	2	2	2	2	4	4	4	4	4	6	6	8	8	8	8	4	4	4	4	2	2	2	2
Standard	2	2	2	2	4	4	8	8	8	8	10	12	12	18	18	18	18	10	8	8	8	4	4	2	2
Master	4	4	4	6	6	8	8	14	14	18	18	24	24	36	36	36	36	24	24	16	16	8	8	4	4

Sure-Snap Second Lower Bicuspid Kits - Distribution

Size	1	2	3	4	5	6	7	8	9	10	11	12	13	14	15	16	17	18	19	20	21	22	23	24	25	26	27	28	29	30	31	32
Starter						1	1	2	2	2	2	2	2	2	2	2	2	2	2	2	2	2	2	2	2	2	2	2	2	2	1	1
Intro						2	2	2	2	2	2	4	4	4	6	6	8	8	8	6	6	4	4	4	4	2	2	2	2	2	2	2
Standard						2	2	2	4	4	6	6	6	8	10	12	14	16	16	16	14	12	10	8	6	6	6	4	4	2	2	2
Master						2	4	4	6	8	10	12	12	16	20	26	28	34	34	34	28	26	20	16	14	12	10	8	6	4	4	2







Starter Kit: 25 banden per kwadrant/bagues par quadrant

Intro Kit: 50 banden per kwadrant/bagues par quadrant

Standard Kit: 100 banden per kwadrant/bagues par quadrant

Master Kit: 200 banden per kwadrant/bagues par quadrant

WELDABLE Lingual Attachments

Lingual Sheats		P/N
	Standard	43-0250-0000
	Cetlin left 8° offset, V-Stop, Hook	43-027L-0000
	Cetlin right 8° offset, V-Stop, Hook	43-027R-0000
	With left Hook, V-Stop	43-028L-0000
	With right Hook, V-Stop	43-028R-0000
	Without V stop	43-0260-0000
	With rotation wings and stops, Upper left and lower right	43-042L-0000
	With rotation wings and stops, Upper right and lower left	43-042R-0000
	Curved Without V-Stops	43-0430-0000

Seating Lugs		P/N
	Flat	43-0340-0000
	Curved	43-0350-0000

Cleat Lingual		P/N
	Small	43-0210-0000
	Medium	43-0220-0000
	Large	43-0230-0000
	Large Optional	43-0240-0000



Lijmen/Colles



GC ORTHO CONNECT

Light Cure Adhesive for brackets

- One step systeem!
- Incl. primer (deze zit reeds in de pasta)
- Te bewaren op kamertemperatuur !
- Lichtuithardend
- 2 spuitjes van 2,9 g + 4 dispensing tips + 2 light protective covers
- **90-1100-0000**

-
- One step systeem!
 - Incl. primer (déjà intégré dans la pâte)
 - À conserver à température ambiante
 - Photopolymérisable
 - 2 seringues de 2,9 g + 4 embouts de distribution + 2 caches lumière
 - **90-1100-0000**



GC ORTHO CONNECT FLOW

Light Cure Adhesive for lingual retainers, stops and aligners attachments

- One step systeem!
- Incl. metal primer
- Te bewaren op kamertemperatuur!
- Lichtuithardend
- 2 spuitjes van 2,7g + 30 dispensing tips + 2 light protective covers
- **90-3100-0000**
- **30 tips 90-2507-P302**

-
- One step systeem!
 - Incl. primer (déjà intégré dans la pâte)
 - À conserver à température ambiante
 - Photopolymérisable
 - 2 seringues de 2,7 g + 30 embouts de distribution + 2 caches lumière
 - **90-3100-0000**
 - **30 embouts 90-2507-P302**



GC ORTHO ETCHING GEL

- 2 spuitjes/seringues 4,8g, 40 tips/embouts
- **90-1400-0000**



GC FUJI ORTHO BAND LC

- Lichtuithardend glasionomeer pasta-pasta versie
- Blauwe kleur
- Bevat fluoride
- Uitstekende hechting ook in een vochtige omgeving
- **003105 : 2 x 13,3 g cartridge**
- **001573 : 1x Paste Pak Dispenser**
- **900549 : 20x Mixing Tips LC**



- Verre ionomère photopolymérisable en pâte/pâte pour le scellement des bagues
- Libération élevée de fluor
- Couleur Bleue
- Excellente adhésion, même dans un environnement humide
- **003105 : 2 x 13,3 g cartridge**
- **001573 : 1x Paste Pak Dispenser**
- **900549 : 20x Mixing Tips LC**

GC FUJI ORTHO BAND

- Idem als de Fuji Ortho Band LC maar is chemisch uithardend
- **001888 : 2x 13,9g cartridges**
- **001573 : 1x Paste Pak Dispenser**

- Même chose que le Fuji Ortho Band LC, mais autopolymérisable.
- **001888 : 2x cartouches de 13,9g**
- **001573 : 1x Distributeur de pâte**



GC ALIGNER CONNECT™

Specifically formulated for aligner attachments

Als eerste in de industrie is GC Aligner Connect speciaal ontwikkeld voor orthodontische aligner attachments. GC Aligner Connect biedt een verbeterde esthetiek, imiteert de glazuur kleurschakeringen van de tand en heeft een hoge duurzaamheid, die slijtage op lange termijn of mogelijke loslating beperkt tijdens de behandeling. Kan gebruikt worden in combinatie met de G-premio Bond, Ortho Solo of Assure.

90-4100-0000 GC Aligner connect - 1 syringe 3,4g with 20 tips

Composite développé pour les traitements par gouttières

La résine composite généralement utilisée pour créer des taquets ne répond pas aux impératifs des traitements par gouttières d'alignement. Aucune résine existante sur le marché n'a spécialement été créée pour cette application. GC Aligner Connect a été développé dans ce sens, afin d'apporter une réponse esthétique par mimétisme de la teinte de la dent et limiter l'usure et les risques de décollement grâce à sa grande résistance. L'adhésion à l'émail se fera par l'intermédiaire d'un agent de collage photopolymérisable (ex: G-premio Bond, Ortho Solo, Assure, etc...). Suivre les instructions de l'agent de collage.

90-4100-0000 GC Aligner connect - 1 syringe 3,4g with 20 tips



GC ESSENTIA LoFlo 900741 HiFlo 900739

- Lichtuithardende radiopake universele composiet
- Ideaal om te restaureren en om retentiedraden te klevan
- Beschikbaar in 1 universele kleur
- 1 spuit 2ml (3,4g) + 20 Dispensing Tips III Plastic

- Un composite photopolymérisable
- Pour les restaurations postérieures ainsi que pour le collage de fils de contention
- Une teinte universelle
- 1 seringue 2ml/(3,4g) + 20 embouts



G-PREMIO BOND

- Stabiele hechting op glazuur, dentine, composiet, edele en non-edele legeringen, zirkonium en alumina.

- 012694

- Composition unique permettant une adhésion élevée sur tous les substrats indirects (composites, métaux précieux et non précieux, alumine, zircone...)

- 012694



GC MI PASTE PLUS & GC MI VARNISH

Weg met de white spots. Met de GC MI Paste Plus en de MI Varnish beschermt u uw patiënt!

De combinatie van fluoride, calcium en fosfaat vormt een sterke bescherm laag. De neutrale pH-waarde van 6,6 maakt het tandglazuur beter bestand tegen zuren en verhindert demineralisatie.

GC Mi Paste Plus: **462886** aarbeï - **462621** munt

GC Mi Varnish: **900749** aardbei - **900750** munt

Finì avec les white spots! Avec GC MI Paste Plus et MI Varnish, vous pouvez protéger votre patient.

L'association du fluorure, du calcium et des phosphates forme une forte couche protectrice. La valeur de pH neutre de 6.6 rend l'émail des dents plus résistant aux acides et empêche la déminéralisation.

GC Mi Paste Plus: **462886** fraise - **462621** menthe

GC Mi Varnish: **900749** fraise - **900750** menthe



GC TRI PLAQUE ID GEL

Plaquedetectie !

Breng de GC Tri Plaque ID Gel op het tandoppervlak aan met een micropenseel of wattenstaafje.

De kleur van de gel geeft het volgende weer:

- Roze of rood: nieuwe plaque
- Blauw of paars: oude plaque van minstens 48 uur oud
- Lichtblauw: oude en sterk zuur producerende plaque

- 004273

Gel révélateur de plaque !

Appliquez GC Tri Plaque ID Gel sur les surfaces de la dent avec un instrument adapté (microbrosse, tampon ou brosse à dent).

Identifier la plaque en observant la couleur du gel

- Rose ou rouge: plaque fraîche
- Bleu ou violet: plaque mature (vieille d'au moins 48 heures)
- Bleu clair: plaque mature et produisant une forte quantité d'acides

- 004273



1ST & FINAL ORTHODONTIC PROPHY PUMICE 600-999

1st & Final is een orthodontisch puimsteen ontworpen voor het polijsten van glazuur.

- Voorgemengd en voorverpakt voor ultiem gemak.
- Voorverpakt - inclusief 200 steriele cups voor individueel gebruik door de patiënt
- Voorgemengd - gewoon openen en aanbrengen met de prophy cup
- Geen toegevoegde chemicaliën - geen smaakstoffen, fluoride of oliën

1st & Final est une pierre ponce orthodontique conçu pour le polissage de l'émail.

- Pré-emballé - incluant 200 gobelets stériles pour un usage individuel du patient
- Pré-mélangé - il suffit d'ouvrir et d'appliquer
- Aucun produit chimique ajouté - sans arômes, sans fluor et sans huiles



ULTRA BAND-LOK BLUE

- Voor het cementeren van banden
 - Kan gebruikt worden voor occlusal build ups
 - Blauwe kleur
 - Bevat fluor
- 600-647**

- Pour la cimentation des bagues
 - Peut être utilisé pour les surévaluation occlusales
 - Couleur bleue
 - Contient fluor
- 600-647**



LUERLOK ULTRA BANDLOK BLUE 600-640S

- 5 g syringe
- Enkelvoudig pasta systeem
- Licht Geactiveerd
- Harsbasis Glas-Ionomeer
- Cement voor alle doeleinden
- Hecht op metaal
- Geeft veel fluoride af
- Blauwe tint
- Hecht op metaal
- Inclusief 1 Luerlok Ultra Bandlok Blue 5g spuit en 5 tips

- Seringue de 5 g
- Système à pâte unique
- Activation par la lumière
- Verre ionomère à base de résine
- Ciment tout usage
- Adhère au métal
- Dégage beaucoup de fluorure
- Teinte bleue
- Comprend 1 seringue Luerlok Ultra Bandlok Bleu de 5g et 5 embouts



ALPHA-ETCH37

- 37% fosforzuur
 - Blauwe Etsgel, 50 g - Dental Technologies
 - Gelijkmatic opruwen van de tand
 - Gemakkelijk af te spoelen
 - Incl. wegwerpspuiten
 - 2 spuiten van 25 ml
- 02-0065**

- 37% d'acide phosphorique
 - Gel de mordantage bleu, 50 g - Technologies dentaires
 - Rugosité régulière de la dent
 - Facile à rincer
 - Y compris les seringues jetables
 - 2 seringues de 25 ml
- 02-0065**



T.K.O. COMPOSITE BITE TURBO GEL PINK 600-058

- Quick light cure acrylic repair
- Gentle impact Resin Matrix (great for occlusal build ups)
- Needle tip dispensing for accurate and ergonomic placement
- Will not wear opposing tooth structure. Relatively easy to remove at the end of treatment.
- Used in both lab and chairside settings
- Pink shade to contrast enabel
- Contains one 3,4g TKOP syringe with 5 tips



ASSURE PLUS

600-002



ETCHANT LIQUID

9g 600-312



PORCELAIN CONDITIONER

8cc 600-704



BARRIER GEL

- 3cc bottle
600-314



PORC-ETCH

- Porcelain etching gel (7g)
- Includes 3cc barrier gel
600-228



MICRO APPLICATOR BRUSHES

- Regular (2.0mm) – Silver
- 100/box
320802



BENDABLE BRUSH APPLICATOR

- Regular
- 144/box
204002



ORTHOBOX

Made in France



OB-PS-001
OrthoBox



OB-S-REC-001
Rebond OrthoBox



72H
IN ADVANCE

OrthoBox
DENTAL by accante®

Een innovatief systeem voor voorgelijmde brackets

Dankzij de Orthobox kan u uw brackets klaarmaken voor elke tandenboog, "pincette + bracket + lijm". Dit proces brengt verschillende voordelen met zich mee, zoals de mogelijkheid om uw gebruikelijke brackets voor te lijmen met de lijm van uw keuze en om de brackets alleen te kleven zonder de hulp van uw assistent(e).

2 goede redenen om deze OrthoBox in uw praktijk te gebruiken.



KLEEF ALLEEN ZONDER DE HULP VAN UW ASSISTENT(E) !

U hoeft geen assistent(e) naast u te hebben tijdens het kleven. De assistent(e) maakt uw brackets met de lijm van uw keuze klaar van tevoren. Dankzij het ergonomische systeem van de OrthoBox zijn de voorgelijmde brackets beschermd tegen het licht.

U werkt autonoom met deze OrthoBox!



BESPAAR TIJD VOOR UZELF EN UW ASSISTENT(E)

Met assistent(e)

Als u wordt bijgestaan door uw assistent(e), zal u nu even snel alleen kunnen werken dankzij de OrthoBox. U wint tijd en uw assistent(e) zal een gemiddelde van 20 minuten winnen om andere taken uit te voeren. Een tijdwinst van 5 min voor u als Orthodontist en +/- 20 min voor uw assistent(e) per plaatsing van brackets

Zonder assistent(e)

Als u al de gewoonte heeft om alleen te kleven, dan zal u ongeveer 5 min winnen tijdens de plaatsing.

Un système innovant de brackets préencollés

L'Orthobox permet une préparation avancée, "précelle + bracket + colle" pour chaque arcade. Ce procédé apporte plusieurs avantages comme par exemple la possibilité de choisir d'encoller vos brackets habituelles avec la colle de votre choix et de coller aisément seul au fauteuil.

2 bonnes raisons d'adopter l'OrthoBox dans votre cabinet



COLLEZ DÉSORMAIS SEUL AU FAUTEUIL !

Plus besoin d'une assistant(e) à côté de vous pendant le collage. L'assistant(e) prépare vos précelles préencollées (brackets + colle de votre choix) à l'avance. Grâce au système ergonomique de l'OrthoBox les précelles préencollées sont à l'abri de la lumière.

Vous travaillez de manière autonome avec l'OrthoBox!



GAGNEZ DU TEMPS POUR VOUS ET VOTRE ASSISTANT(E) !

Avec assistent(e)

Si vous aviez l'habitude d'être secondé, vous collez maintenant aussi rapidement seul, qu'auparavant avec votre assistent(e) qui gagne ainsi, en moyenne, 20 minutes à consacrer à d'autres tâches. Un gain de temps de 5 min pour vous et de 20 min pour votre assistent(e) pour 1 collage!

Sans assistent(e)

Si vous aviez déjà l'habitude de coller seul, vous gagnez environ 5 minutes.

SCANDEE RETRACTOR

5054 Scandee Lipretr.
Medium - PC - Clear - 1 pc
5055 Scandee Lipretr.
Large - PC - Clear - 1 pc
5066 Scandee Lipretr.
Medium - PP - Opaque - 1 pc
5076 Scandee Lipretr.
Small - PP - Opaque - 1 pc



EXPANDO CHEEK RETRACTOR

600-049 Assortment (1 of ea.)
600-050 Adult (2/pk)
600-051 Pedo (2/pk)
600-052 Teen (2/pk)



NOLA DRY FIELD SYSTEMS

300-400 Small
300-401 Large



EXPANDO CHEEK RETRACTOR

07-0254 Small
07-0255 Medium
07-0256 Large



BONDING LED LIGHT



MINI LED ORTHO 2

F05220

Satelec MiniLed Ortho II
incl. 1 batterie

F05211

Satelec Batterie MiniLed II

- Power: 3000mW/cm²
(Ø5.5mm light guide)
- 15 patients
- Customizable signal: An alert (beep, micro-flash, mixed or no alert) prompts the user to move to the next curing position every 4 sec.
- Time 4, 8, 12 and 32 sec.



GC D-LIGHT PRO LED CURING LIGHT

901412

GC D-Light Pro LED Curing Light
incl. 2 batteries

- Power: 1400mW/cm² (Ø8mm light guide)
- Time 20 sec.
- Dual wavelength LED curing light, blue and violet LED. The Detection (DT) mode is based solely on the violet LED and so presents only one peak in its spectrum. Its aim is not to polymerise materials but to help you visualise bacterial activity and fluorescent materials.
- Also visualisation of active plaque. The first curing light that can be fully autoclaved after its electronic components have been removed from the hand-piece, ensuring optimal hygiene for all your special cases.



GC



Draden/Fils

Metal - Rhodium - Aesthetic

DIFFERENT ARCHFORMS

Form A-C-D

Form  Accuform/Trueform I

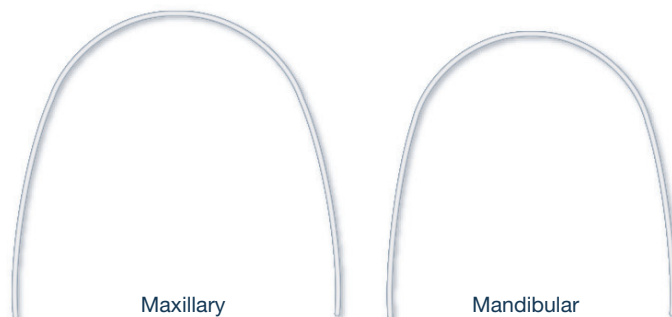

Form  Ideal Form/Europa I

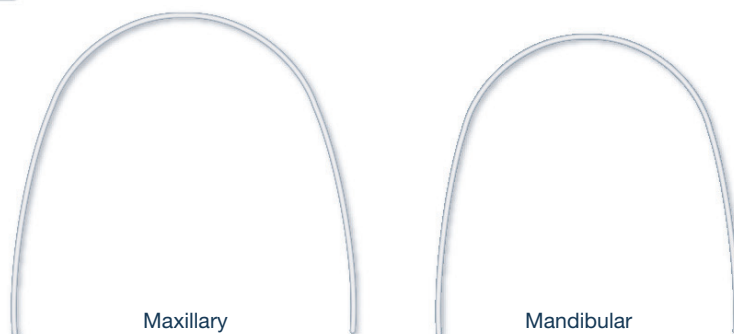

Form  Damon Form





INITIALLOY

Superelastic archwires



INITIALLOY Round Archwires

Force	Dimension	A		C	
		Maxillary	Mandibular	Maxillary	Mandibular
Light	.014"	71-A1U0-0014	71-A1L0-0014	71-C1U0-0014	71-C1L0-0014
	.016"	71-A1U0-0016	71-A1L0-0016	71-C1U0-0016	71-C1L0-0016
	.018"	71-A1U0-0018	71-A1L0-0018	71-C1U0-0018	71-C1L0-0018
Medium	.012"	71-A2U0-0012	71-A2L0-0012	—	—
	.014"	71-A2U0-0014	71-A2L0-0014	71-C2U0-0014	71-C2L0-0014
	.014" "Dimple"	71-A2UD-0014	71-A2LD-0014	71-C2UD-0014	71-C2LD-0014
	.016"	71-A2U0-0016	71-A2L0-0016	71-C2U0-0016	71-C2L0-0016
	.016" "Dimple"	71-A2UD-0016	71-A2LD-0016	71-C2UD-0016	71-C2LD-0016
	.018"	71-A2U0-0018	71-A2L0-0018	71-C2U0-0018	71-C2L0-0018
	.018" "Dimple"	71-A2UD-0018	71-A2LD-0018	71-C2UD-0018	71-C2LD-0018
Heavy	.020"	71-A2U0-0020	71-A2L0-0020	—	—
	.014"	71-A3U0-0014	71-A3L0-0014	—	—
	.016"	71-A3U0-0016	71-A3L0-0016	71-C3U0-0016	71-C3L0-0016
	.018"	71-A3U0-0018	71-A3L0-0018	—	—

Draden in solo-pack en per 10 verpakt / Fils en pack solo et par 10





BIO-EDGE

Superelastic archwires



BIO-EDGE Square and Rectangular Archwires

Force/Dimension	A		C	
	Maxillary	Mandibular	Maxillary	Mandibular
	P/N		P/N	
80 g				
.016"x.016"	72-A1U0-1616	72-A1L0-1616	72-C1U0-1616	72-C1L0-1616
.016"x.022"	72-A1U0-1622	72-A1L0-1622	72-C1U0-1622	72-C1L0-1622
100 g				
.017"x.025"	-	-	72-C1U0-1725	72-C1L0-1725
.018"x.018"	-	-	72-C1U0-1818	72-C1L0-1818
.018"x.025"	-	-	72-C1U0-1825	72-C1L0-1825
.020"x.020"	72-A1U0-2020	72-A1L0-2020	72-C1U0-2020	72-C1L0-2020
160 g				
.016"x.016"	72-A2U0-1616	72-A2L0-1616	72-C2U0-1616	72-C2L0-1616
.016"x.016" "Dimple"	72-A2UD-1616	72-A2LD-1616	72-C2UD-1616	72-C2LD-1616
.016"x.022"	72-A2U0-1622	72-A2L0-1622	72-C2U0-1622	72-C2L0-1622
.016"x.022" "Dimple"	72-A2UD-1622	72-A2LD-1622	72-C2UD-1622	72-C2LD-1622
200 g				
.017"x.025"	72-A2U0-1725	72-A2L0-1725	72-C2U0-1725	72-C2L0-1725
.017"x.025" "Dimple"	72-A2UD-1725	72-A2LD-1725	72-C2UD-1725	72-C2LD-1725
.018"x.018"	72-A2U0-1818	72-A2L0-1818	72-C2U0-1818	72-C2L0-1818
.018"x.025"	72-A2U0-1825	72-A2L0-1825	72-C2U0-1825	72-C2L0-1825
.019"x.025"	72-A2U0-1925	72-A2L0-1925	-	-
.020"x.020"	72-A2U0-2020	72-A2L0-2020	72-C2U0-2020	72-C2L0-2020
.021"x.028"	72-A2U0-2128	72-A2L0-2128	-	-
240 g				
.016"x.022"	72-A3U0-1622	72-A3L0-1622	72-C3U0-1622	72-C3L0-1622
300 g				
.018"x.025"	72-A3U0-1825	72-A3L0-1825	-	-

Force/Dimension	D
	P/N
160 g	Universal
.014"X.025"	72-D200-1425
.016"X.022"	72-D200-1622
200 g	
.018"X.025"	72-D200-1825
.020"X.020"	72-D200-2020

Draden in solo-pack en per 10 verpakt / Fils en pack solo et par 10

LINGUAL ARCHWIRES



INITIALLOY Lingual Archwires

	N1		N2	
	P/N		P/N	
Force/Dimension	Maxillary	Mandibular	Maxillary	Mandibular
Light				
.012"	71-N1U1-0012	71-N1L1-0012	71-N1U2-0012	71-N1L2-0012
.014"	71-N1U1-0014	71-N1L1-0014	71-N1U2-0014	71-N1L2-0014
.016"	71-N1U1-0016	71-N1L1-0016	71-N1U2-0016	71-N1L2-0016

	N3		N4	
	P/N		P/N	
Force/Dimension	Maxillary	Mandibular	Maxillary	Mandibular
Light				
.012"	71-N1U3-0012	71-N1L3-0012	71-N1U4-0012	71-N1L4-0012
.014"	71-N1U3-0014	71-N1L3-0014	71-N1U4-0014	71-N1L4-0014
.016"	71-N1U3-0016	71-N1L3-0016	71-N1U4-0016	71-N1L4-0016

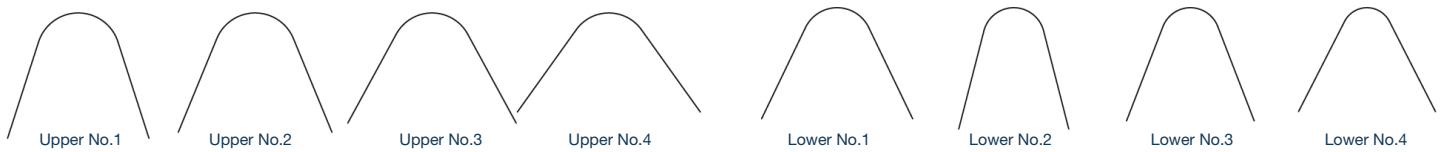

BIO-EDGE Lingual Archwires

	N1		N2	
	P/N		P/N	
Force/Dimension	Maxillary	Mandibular	Maxillary	Mandibular
80 g				
.016"x.016"	72-N1U1-1616	72-N1L1-1616	72-N1U2-1616	72-N1L2-1616
.016"x.022"	72-N1U1-1622	72-N1L1-1622	72-N1U2-1622	72-N1L2-1622
100 g				
.018"x.018"	72-N1U1-1818	72-N1L1-1818	72-N1U2-1818	72-N1L2-1818
.018"x.025"	72-N1U1-1825	72-N1L1-1825	72-N1U2-1825	72-N1L2-1825

	N3		N4	
	P/N		P/N	
Force/Dimension	Maxillary	Mandibular	Maxillary	Mandibular
80 g				
.016"x.016"	72-N1U3-1616	72-N1L3-1616	72-N1U4-1616	72-N1L4-1616
.016"x.022"	72-N1U3-1622	72-N1L3-1622	72-N1U4-1622	72-N1L4-1622
100 g				
.018"x.018"	72-N1U3-1818	72-N1L3-1818	72-N1U4-1818	72-N1L4-1818
.018"x.025"	72-N1U3-1825	72-N1L3-1825	72-N1U4-1825	72-N1L4-1825

Draden in solo-pack en per 10 verpakt / Fils en pack solo et par 10



BIO-ACTIVE & BIO-ACTIVE Light



100 gf 200 gf 300 gf

BIO-ACTIVE

Dimension	A		C	
	Maxillary	Mandibular	Maxillary	Mandibular
.016" x .016"	70-A0U0-1616	70-A0L0-1616	70-C0U0-1616	70-C0L0-1616
.016" x .022"	70-A0U0-1622	70-A0L0-1622	70-C0U0-1622	70-C0L0-1622
.016" x .022" "Dimple"	70-A0UD-1622	70-A0LD-1622	70-C0UD-1622	70-C0LD-1622
.018" x .018"	70-A0U0-1818	70-A0L0-1818	70-C0U0-1818	70-C0L0-1818
.018" x .018" "Dimple"	70-A0UD-1818	70-A0LD-1818	70-C0UD-1818	70-C0LD-1818
.018" x .025"	70-A0U0-1825	70-A0L0-1825	70-C0U0-1825	70-C0L0-1825
.019" x .025"	70-A0U0-1925	70-A0L0-1925	70-C0U0-1925	70-C0L0-1925
.020" x .020"	70-A0U0-2020	70-A0L0-2020	70-C0U0-2020	70-C0L0-2020
.020" x .020" "Dimple"	70-A0UD-2020	70-A0LD-2020	70-C0UD-2020	70-C0LD-2020
.020" x .025"	70-A0U0-2025	70-A0L0-2025	70-C0U0-2025	70-C0L0-2025

Dimension	D
	Universal
.014" x .025"	70-D000-1425
.016" x .022"	70-D000-1622
.018" x .025"	70-D000-1825
.020" x .020"	70-D000-2020



50 gf 150 gf 250 gf

BIO-ACTIVE Light

Dimension	A		C		D
	Maxillary	Mandibular	Maxillary	Mandibular	Universal
.013"	-	-	-	-	70-D100-0013
.014"	-	-	-	-	70-D100-0014
.016"	-	-	-	-	70-D100-0016
.014" x .025"	-	-	-	-	70-D100-1425
.016" x .016"	-	-	-	-	70-D100-1616
.016" x .022"	-	-	-	-	70-D100-1622
.017" x .025"	-	-	-	-	70-D100-1725
.018" x .018"	70-A1U0-1818	70-A1L0-1818	70-C1U0-1818	70-C1L0-1818	70-D100-1818
.018" x .025"	-	-	-	-	70-D100-1825
.019" x .025"	-	-	-	-	70-D100-1925
.020" x .020"	70-A1U0-2020	70-A1L0-2020	70-C1U0-2020	70-C1L0-2020	70-D100-2020
.022" x .018"	70-A1U0-2218	70-A1L0-2218	70-C1U0-2218	70-C1L0-2218	70-D100-2218

Draden in solo-pack en per 10 verpakt / Fils en pack solo et par 10

SUPERELASTIC Niti Archwires



Dimension	A		C	
	Maxillary	Mandibular	Maxillary	Mandibular
.012"	77-A0U0-0012	77-A0L0-0012	77-C0U0-0012	77-C0L0-0012
.014"	77-A0U0-0014	77-A0L0-0014	77-C0U0-0014	77-C0L0-0014
.016"	77-A0U0-0016	77-A0L0-0016	77-C0U0-0016	77-C0L0-0016
.018"	77-A0U0-0018	77-A0L0-0018	77-C0U0-0018	77-C0L0-0018
.020"	77-A0U0-0020	77-A0L0-0020	77-C0U0-0020	77-C0L0-0020
.016"x.016"	77-A0U0-1616	77-A0L0-1616	77-C0U0-1616	77-C0L0-1616
.016"x.022"	77-A0U0-1622	77-A0L0-1622	77-C0U0-1622	77-C0L0-1622
.017"x.025"	77-A0U0-1725	77-A0L0-1725	77-C0U0-1725	77-C0L0-1725
.018"x.018"	—	—	77-C0U0-1818	77-C0L0-1818
.018"x.025"	77-A0U0-1825	77-A0L0-1825	77-C0U0-1825	77-C0L0-1825
.019"x.025"	77-A0U0-1925	77-A0L0-1925	77-C0U0-1925	77-C0L0-1925
.020"x.020"	77-A0U0-2020	77-A0L0-2020	77-C0U0-2020	77-C0L0-2020
.021"x.025"	77-A0U0-2125	77-A0L0-2125	77-C0U0-2125	77-C0L0-2125

Draden per 10 verpakt / Emballé par 10 fils

DEEP BITE Opener CTA



A real NiTi-made utility arch, it is the tool of choice for vertical corrections. Front segment 28 mm or 34 mm, Intrusion step 15 or 22 mm.

Dimension	P/N	
	Maxillary	Mandibular
.016"x.022" 15 mm (extraction cases)	77-F1U0-1622	77-F1L0-1622
.016"x.022" 22 mm	77-F2U0-1622	77-F2L0-1622
.017"x.025" 15 mm (extraction cases)	77-F1U0-1725	77-F1L0-1725
.017"x.025" 22 mm	77-F2U0-1725	77-F2L0-1725

Draden per 10 verpakt / Emballé par 10 fils

TITANIUM-MOLYBDENUM Beta-Titanium Archwires



Dimension	A		C	
	Maxillary	Mandibular	Maxillary	Mandibular
.016"	73-A0U0-0016	73-A0L0-0016	—	—
.018"	73-A0U0-0018	73-A0L0-0018	—	—
.016"x.022"	73-A0U0-1622	73-A0L0-1622	73-C0U0-1622	73-C0L0-1622
.017"x.025"	73-A0U0-1725	73-A0L0-1725	73-C0U0-1725	73-C0L0-1725
.018" X.018"	73-A0U0-1818	73-A0L0-1818	73-C0U0-1818	73-C0L0-1818
.018"x.025"	73-A0U0-1825	73-A0L0-1825	73-C0U0-1825	73-C0L0-1825
.019"x.025"	73-A0U0-1925	73-A0L0-1925	73-C0U0-1925	73-C0L0-1925
.021"x.025"	73-A0U0-2125	73-A0L0-2125	73-C0U0-2125	73-C0L0-2125

Draden in solo-pack en per 10 verpakt / Fils en pack solo et par 10



Straight Length

Dimension	P/N
.032"	73-L000-0032
.017"x.025"	73-L000-1725
.019"x.025"	73-L000-1925

10 draden per tube / 10 fils par tube

Draden/Fils



MONOSTRANDED Stainless steel Archwires

Regular	A		C	
	P/N		P/N	
Dimension	Maxillary	Mandibular	Maxillary	Mandibular
.014"	78-A2U0-0014	78-A2L0-0014	78-C2U0-0014	78-C2L0-0014
.016"	78-A2U0-0016	78-A2L0-0016	78-C2U0-0016	78-C2L0-0016
.018"	78-A2U0-0018	78-A2L0-0018	78-C2U0-0018	78-C2L0-0018
.020"	78-A2U0-0020	78-A2L0-0020	78-C2U0-0020	78-C2L0-0020
.016"x.016"	78-A2U0-1616	78-A2L0-1616	78-C2U0-1616	78-C2L0-1616
.016"x.022"	78-A2U0-1622	78-A2L0-1622	78-C2U0-1622	78-C2L0-1622
.0175"x.0175"	-	-	78-C2U0-1717	78-C2L0-1717
.017"x.025"	78-A2U0-1725	78-A2L0-1725	78-C2U0-1725	78-C2L0-1725
.018"x.018"	78-A2U0-1818	78-A2L0-1818	-	-
.018"x.022"	78-A2U0-1822	78-A2L0-1822	-	-
.018"x.025"	78-A2U0-1825	78-A2L0-1825	78-C2U0-1825	78-C2L0-1825
.019"x.019"	78-A2U0-1919	78-A2L0-1919	-	-
.019"x.025"	78-A2U0-1925	78-A2L0-1925	78-C2U0-1925	78-C2L0-1925
.020"x.020"	78-A2U0-2020	78-A2L0-2020	78-C2U0-2020	78-C2L0-2020
.020"x.025"	-	-	78-C2U0-2025	78-C2L0-2025
.021"x.025"	78-A2U0-2125	78-A2L0-2125	78-C2U0-2125	78-C2L0-2125
.021"x.028"	78-A2U0-2128	78-A2L0-2128	-	-

Draden in solo-pack en per 10 verpakt / Fils en pack solo et par 10

MONOSTRANDED Stainless Steel Archwires

GT (Gold Tone)	A		C	
	P/N		P/N	
Dimension	Maxillary	Mandibular	Maxillary	Mandibular
.014"	78-A4U0-0014	78-A4L0-0014	78-C4U0-0014	78-C4L0-0014
.016"	78-A4U0-0016	78-A4L0-0016	78-C4U0-0016	78-C4L0-0016
.018"	78-A4U0-0018	78-A4L0-0018	78-C4U0-0018	78-C4L0-0018
.016"x.016"	78-A4U0-1616	78-A4L0-1616	78-C4U0-1616	78-C4L0-1616
.016"x.022"	78-A4U0-1622	78-A4L0-1622	78-C4U0-1622	78-C4L0-1622
.017"x.025"	78-A4U0-1725	78-A4L0-1725	78-C4U0-1725	78-C4L0-1725
.018"x.025"	78-A4U0-1825	78-A4L0-1825	78-C4U0-1825	78-C4L0-1825
.019"x.025"	78-A4U0-1925	78-A4L0-1925	78-C4U0-1925	78-C4L0-1925

Draden in solo-pack en per 10 verpakt / Fils en pack solo et par 10

MONOSTRANDED Stainless Steel Archwires

	P/N		P/N
14" Straight Length (50 wires/tube)	ST	14" Straight Length (10 wires/tube)	ST
Dimension	P/N	Dimension	P/N
.014"	78-L200-0014	.016"x.016"	78-L200-1616
.016"	78-L200-0016	.016"x.022"	78-L200-1622
.018"	78-L200-0018	.017"x.025"	78-L200-1725
.020"	78-L200-0020	.018"x.025"	78-L200-1825
		.019"x.025"	78-L200-1925
		.021"x.025"	78-L200-2125



Stainless Steel Archwires

	RIGHT FORM (True Form)		GLOBAL (Europa I)	
	upper	lower	upper	lower
.012	250-138	250-139	250-138G	250-139G
.014	250-140	250-150	250-140G	250-150G
.016	250-141	250-151	250-141G	250-151G
.018	250-142	250-152	250-142G	250-152G
.020	250-143	250-153	250-143G	250-153G

Draden per 50 verpakt / Emballé par 50 fils

	RIGHT FORM (True Form)		GLOBAL (Europa I)	
	upper	lower	upper	lower
.016x.016	250-144	250-154	250-144G	250-154G
.016x.022	250-145	250-155	250-145G	250-155G
.016x.025	250-177	250-178	250-177G	250-178G
.017x.022	250-160	250-162	-	-
.017x.025	250-146	250-156	250-146G	250-156G
.018x.018	250-164	250-166	250-164G	250-166G
.018x.022	250-171	250-172	250-171G	250-172G
.018x.025	250-147	250-157	250-147G	250-157G
.019x.025	250-148	250-158	250-148G	250-158G
.020x.020	250-165	250-168	250-165G	250-168G
.021x.025	250-149	250-159	250-149G	250-159G

Draden per 10 verpakt / Emballé par 10 fils

MULTISTRANDED Stainless steel Archwires



TRIFLEX

is a three strands round twisted archwire. Preformed. 10 per box.

A	
Dimension	P/N
.0175"	78-AT00-0175

QUADFLEX

is a four strands rectangular twisted archwire. Preformed. 10 per box.

Dimension	A	
	Maxillary	Mandibular
.016"x.022"	78-AQU0-1622	78-AQL0-1622
.017"x.025"	78-AQU0-1725	78-AQL0-1725
.019"x.025"	78-AQU0-1925	78-AQL0-1925



PENTAFLEX

is a rectangular coaxial wire (five strands twisted around a central core), straight length or preformed, 10 per box.

Dimension	A		
	P/N	P/N	P/N
	14" Straight length	Maxillary	Mandibular
.0155"	78-LP00-0155	78-APU0-0016	78-APL0-0016
.0175"	78-LP00-0175	78-APU0-0175	78-APL0-0175
.0195"	78-LP00-0195	—	—
.0215"	78-LP00-0215	—	—



HEXAFLEX

is a round 6-stranded coaxial wire. In 30' spools (9m30)

Dimension	P/N
.0175"	30" spool 78-SH00-0175



MULTIFLEX

is an 8-stranded twisted wire. 10 archwires per box.

Dimension	A	
	P/N	P/N
	Maxillary	Mandibular
.016"x.022"	78-AMU0-1622	78-AML0-1622
.017"x.025"	78-AMU0-1725	78-AML0-1725
.018"x.025"	78-AMU0-1825	78-AML0-1825
.019"x.025"	78-AMU0-1925	78-AML0-1925
.021"x.025"	78-AMU0-2125	78-AML0-2125



BIOALLOY WIRE



This cobalt-chromium wire is appreciated for its formability and its capacity to accept extreme loops, straight length, pack of 10.

Dimension	P/N
.016"x.016"	78-L000-1616
.016"x.022"	78-L000-1622
.032"	78-L000-0032
.036"	78-L000-0036



HOOKS and STOPS for Archwires

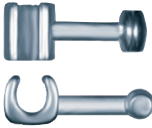
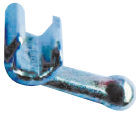

OPENED

	Description	P/N
	T-Bar Surgical Hook, Universal (Bag of 10)	66-0110-0001
	Straight Open Hook, .018" x .025", Optimized for Initialloy Archwires (Bag of 10)	66-0111-0008
	Curved Hook (Bag of 20)	66-0110-0003
	Stop (Bag of 20) Stop, .018" x .025", Optimized for Initialloy Archwires (Bag of 10) Stop, .022" x .028", Optimized for Initialloy Archwires (Bag of 10)	66-0120-0002 66-0121-0004 66-0122-0004

CLOSED

	Description	Dimension	P/N
	Sliding Hooks for Elastics (Bag of 40) Sliding Hooks for Elastics (Bag of 40)	.018"x.025" .022"x.028"	66-0211-0011 66-0212-0011
	Sliding Stops, 2 mm (Bag of 20) Sliding Stops, 3 mm (Bag of 20) Sliding Stops, 2 mm (Bag of 20) Sliding Stops, 3 mm (Bag of 20)	.012"/.016" .012"/.016" .018"/.025" .018"/.025"	66-0221-0006 66-0221-0007 66-0222-0006 66-0222-0007

LIGATURES & KOBAYASHI



LIGATURES

PREFORMED Long (Pack of 600)

Description	P/N
.008"	67-0110-0008
.009"	67-0110-0009
.010"	67-0110-0010
.011"	67-0110-0011
.012"	67-0110-0012

PREFORMED Short, ivory-coloured (Pack of 100)

Description	P/N
.011" Ivory coloured Coat	67-0240-0011
.012" Tooth color	67-0140-0012

PREFORMED Long, ivory-coloured (Pack of 100)

Description	P/N
.011" Ivory coloured	67-0140-0011

PREFORMED Short, .010" (Box of 1000)

Description	P/N
.010"	67-0210-0010

PREFORMED Short Angulated, .010" (Box of 1000)

Description	P/N
.010"	67-0211-0010

LIGATURE .010" (70 g Spool)

Description	P/N
.010"	67-0300-0010
.011" Ivory coloured Coat	67-0360-0011



KOBAYASHI

LONG

Description	P/N
Kobayashi .012" Bag of 100	67-0120-0012
Kobayashi .014" Bag of 100	67-0120-0014

SHORT

Description	P/N
Kobayashi Legend .012" twist, Bag of 100	67-0220-0012
Kobayashi .013" Ivory coloured Coat Bag of 100	67-0250-0013

REVERSE CURVE

SUPER ELASTIC NITINOL (STRAIGHT LEG)



10/pk	upper	lower
.012	226-260	226-261
.014	226-262	226-263
.016	226-264	226-265
.018	226-266	226-267
.20	226-268	226-269
.016x.016	226-270	226-271
.016x.022	226-272	226-273
.017x.025	226-274	226-275
.018x.018	226-276	226-277
.018x.025	226-278	226-279
.019x.025	226-280	226-281



SUPER ELASTIC NITINOL

10/pk	upper	lower
.016	226-204	226-205
.018	226-206	226-207
.016x.016	226-210	226-211
.016x.022	226-212	226-213
.017x.025	226-214	226-215
.018x.018	226-216	226-217
.018x.025	226-218	226-219
.019x.025	226-220	226-221

ARCHWIRES



G4™ NICKEL TITANIUM
Available in:

- All Archforms
- Pre-Stopped
- Lingual Arches
- Pre-Torqued
- G4orce™ Triple Force
- Ultraesthetic™ Tooth-Colored
- Reverse Curve

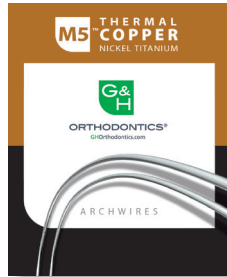

M5™ THERMAL COPPER NICKEL TITANIUM
Available in:

- All Archforms
- Pre-Stopped
- Lingual Arches
- Reverse Curve



TitanMoly™ TITANIUM MOLYBDENUM
Available in:

- 5 Archforms
- T-Loop
- Lingual Arches



S304 VM STAINLESS STEEL
Available in:

- All Archforms
- Ultraesthetic™ Tooth-Colored
- Lingual Arches



XR1™ HEAT-TREATED STAINLESS STEEL
Available in:

- All Archforms
- Brass Ball-Post Posted Arches



ULTRAESTHETIC™ TOOTH-COLORED
Available in:

- 5 Archforms
- G4™ NiTi
- Stainless Steel
- Reverse Curve
- Pre-Stopped



MULTI-STRAND STAINLESS STEEL
Available in:

- 2 Archforms
- Four Strand Varieties:
 - 3-Strand (twisted)
 - 6-Strand (coaxial)
 - 7-Strand (twisted)
 - 8-Strand (woven)

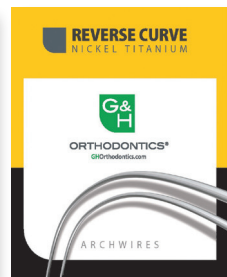

REVERSE CURVE NICKEL TITANIUM
Available in:

- RC 1 & 3
- Europa™ II
- Pre-Stopped
- Pre-Torqued
- Thermal Copper
- Ultraesthetic™ Tooth-Colored



LOOPED STAINLESS STEEL
Available in:

- Trueform™
- T-Loop
- Keyhole Loop



POSTED STAINLESS STEEL
Available in:

- 4 Archforms
- Heat-Treated w/ Brass Ball-Post
- Straight Brass Post

ARCH WIRE BOX

AWSCSLD Bulk wire box



ARCH WIRE DISPENSER

AWDSA100

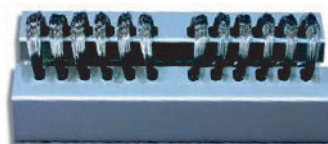

DELUXE ARCHWIRE RACK W/COVER

700-066

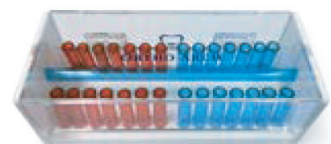

WIREFORMS

Our most popular Archforms

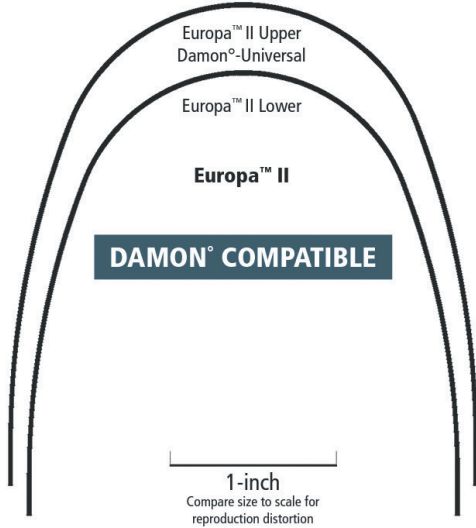
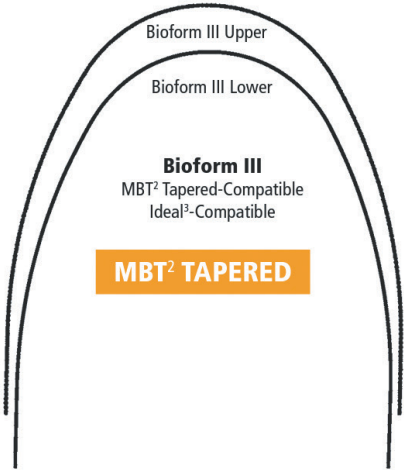
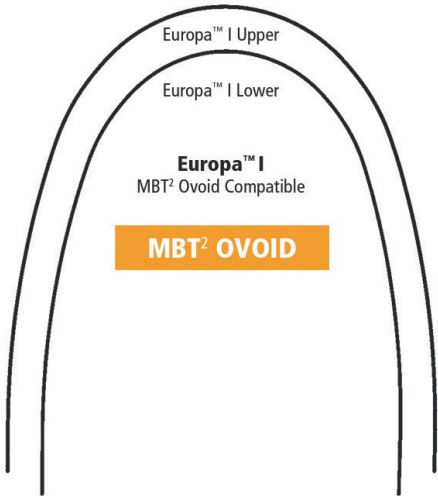
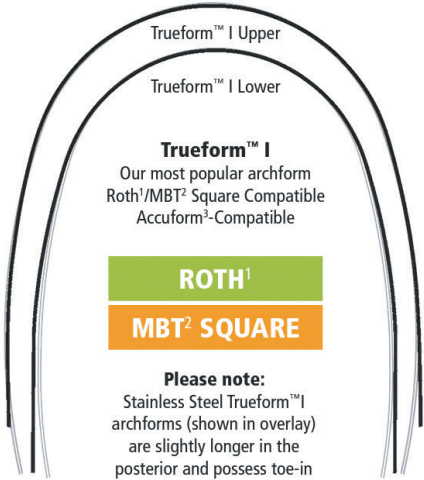



G4 NICKEL TITANIUM Archwires

SIZE	TRUEFORM™ I		EUROPA™ I		BIOFORM III		EUROPA™ II (Damon Comp.)	
	UPPER	LOWER	UPPER	LOWER	UPPER	LOWER	UPPER	LOWER
.012	G4TFU012	G4TFL012	G4EFU012	G4EFL012	G4BF3U012	G4BF3L012	G4EFU112	G4EFL112
.013	-	-	G4EFU013	G4EFL013	-	-	G4EFU113	G4EFL113
.014	G4TFU014	G4TFL014	G4EFU014	G4EFL014	G4BF3U014	G4BF3L014	G4EFU114	G4EFL114
.016	G4TFU016	G4TFL016	G4EFU016	G4EFL016	G4BF3U016	G4BF3L016	G4EFU116	G4EFL116
.018	G4TFU018	G4TFL018	G4EFU018	G4EFL018	G4BF3U018	G4BF3L018	G4EFU118	G4EFL118
.020	G4TFU020	G4TFL020	G4EFU020	G4EFL020	G4BF3U020	G4BF3L020	G4EFU120	G4EFL120
.014x.025	G4TFU1425	-	G4EFU1425	G4EFL1425	-	-	G4EFU3425	G4EFL3425
.016x.016	G4TFU1616	G4TFL1616	G4EFU1616	G4EFL1616	G4BF3U1616	G4BF3L1616	G4EFU3616	G4EFL3616
.016x.022	G4TFU1622	G4TFL1622	G4EFU1622	G4EFL1622	G4BF3U1622	G4BF3L1622	G4EFU3622	G4EFL3622
.016x.025	-	-	G4EFU1625	G4EFL1625	-	-	G4EFU3625	G4EFL3625
.017x.017	-	-	G4EFU1717	G4EFL1717	-	-	G4EFU3717	G4EFL3717
.017x.025	G4TFU1725	G4TFL1725	G4EFU1725	G4EFL1725	G4BF3U1725	G4BF3L1725	G4EFU3725	G4EFL3725
.018x.018	G4TFU1818	G4TFL1818	G4EFU1818	G4EFL1818	G4BF3U1818	G4BF3L1818	G4EFU3818	G4EFL3818
.018x.025	G4TFU1825	G4TFL1825	G4EFU1825	G4EFL1825	G4BF3U1825	G4BF3L1825	G4EFU3825	G4EFL3825
.019x.025	G4TFU1925	G4TFL1925	G4EFU1925	G4EFL1925	G4BF3U1925	G4BF3L1925	G4EFU3925	G4EFL3925
.020x.020	G4TFU2020	G4TFL2020	G4EFU2020	G4EFL2020	G4BF3U2020	G4BF3L2020	G4EFU3020	G4EFL3020
.021x.025	G4TFU2125	G4TFL2125	G4EFU2125	G4EFL2125	G4BF3U2125	G4BF3L2125	G4EFU3125	G4EFL3125
.022x.028	G4TFU2228	G4TFL2228	-	-	-	-	-	-

verpakt per 25 draden/emballé par 25 fils



G4 Nickel Titanium Pre-Stopped Archwires

SIZE	TRUEFORM™ I		EUROPA™ I		BIOFORM III		EUROPA™ II (Damon Comp.)	
	UPPER	LOWER	UPPER	LOWER	UPPER	LOWER	UPPER	LOWER
.012	G4TFU012CB	G4TFL012CB	G4EFU012CB	G4EFL012CB	G4BF3U012CB	G4BF3L012CB	G4EFU112CB	G4EFL112CB
.013	-	-	-	-	-	-	G4EFU113CB	G4EFL113CB
.014	G4TFU014CB	G4TFL014CB	G4EFU014CB	G4EFL014CB	G4BF3U014CB	G4BF3L014CB	G4EFU114CB	G4EFL114CB
.016	G4TFU016CB	G4TFL016CB	G4EFU016CB	G4EFL016CB	G4BF3U016CB	G4BF3L016CB	G4EFU116CB	G4EFL116CB
.018	G4TFU018CB	G4TFL018CB	G4EFU018CB	G4EFL018CB	G4BF3U018CB	G4BF3L018CB	G4EFU118CB	G4EFL118CB
.020	G4TFU020CB	G4TFL020CB	G4EFU020CB	G4EFL020CB	G4BF3U020CB	G4BF3L020CB	G4EFU120CB	G4EFL120CB
.014x.025	-	-	G4EFU1425CB	G4EFL1425CB	-	-	G4EFU3425CB	G4EFL3425CB
.016x.016	G4TFU1616CB	G4TFL1616CB	G4EFU1616CB	G4EFL1616CB	G4BF3U1616CB	G4BF3L1616CB	G4EFU3616CB	G4EFL3616CB
.016x.022	G4TFU1622CB	G4TFL1622CB	G4EFU1622CB	G4EFL1622CB	G4BF3U1622CB	G4BF3L1622CB	G4EFU3622CB	G4EFL3622CB
.016x.025	-	-	G4EFU1625CB	G4EFL1625CB	-	-	G4EFU3625CB	G4EFL3625CB
.017x.017	-	-	G4EFU1717CB	G4EFL1717CB	-	-	G4EFU3717CB	G4EFL3717CB
.017x.025	G4TFU1725CB	G4TFL1725CB	G4EFU1725CB	G4EFL1725CB	G4BF3U1725CB	G4BF3L1725CB	G4EFU3725CB	G4EFL3725CB
.018x.018	G4TFU1818CB	G4TFL1818CB	G4EFU1818CB	G4EFL1818CB	G4BF3U1818CB	G4BF3L1818CB	G4EFU3818CB	G4EFL3818CB
.018x.025	G4TFU1825CB	G4TFL1825CB	G4EFU1825CB	G4EFL1825CB	G4BF3U1825CB	G4BF3L1825CB	G4EFU3825CB	G4EFL3825CB
.019x.025	G4TFU1925CB	G4TFL1925CB	G4EFU1925CB	G4EFL1925CB	G4BF3U1925CB	G4BF3L1925CB	G4EFU3925CB	G4EFL3925CB
.020x.020	G4TFU2020CB	G4TFL2020CB	G4EFU2020CB	G4EFL2020CB	G4BF3U2020CB	G4BF3L2020CB	G4EFU3020CB	G4EFL3020CB

verpakt per 25 draden/emballé par 25 fils

Draden/Fils

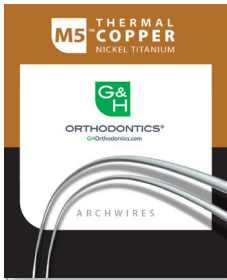

M5 THERMAL COPPER NICKEL TITANIUM Archwires



Optional pre-stopped add 'CB'
to the end of part number

SIZE	TRUEFORM™ I		EUROPA™ I		BIOFORM III		EUROPA™ II (Damon Comp.)	
	UPPER	LOWER	UPPER	LOWER	UPPER	LOWER	UPPER	LOWER
.012	M5TFU012	M5TFL012	M5EFU012	M5EFL012	M5BF3U012	M5BF3L012	M5EFU112	M5EFL112
.014	M5TFU014	M5TFL014	M5EFU014	M5EFL014	M5BF3U014	M5BF3L014	M5EFU114	M5EFL114
.016	M5TFU016	M5TFL016	M5EFU016	M5EFL016	M5BF3U016	M5BF3L016	M5EFU116	M5EFL116
.018	M5TFU018	M5TFL018	M5EFU018	M5EFL018	M5BF3U018	M5BF3L018	M5EFU118	M5EFL118
.020	M5TFU020	M5TFL020	M5EFU020	M5EFL020	M5BF3U020	M5BF3L020	M5EFU120	M5EFL120
.014x.025	M5TFU1425	M5TFL1425	-	-	-	-	M5EFU3425	M5EFL3425
.016x.016	M5TFU1616	M5TFL1616	M5EFU1616	M5EFL1616	M5BF3U1616	M5BF3L1616	M5EFU3616	M5EFL3616
.016x.022	M5TFU1622	M5TFL1622	M5EFU1622	M5EFL1622	M5BF3U1622	M5BF3L1622	M5EFU3622	M5EFL3622
.016x.025	M5THU1625	M5TFL1625	-	-	-	-	M5EFU3625	M5EFL3625
.017x.017	M5TFU1717	M5TFL1717	M5EFU1717	M5EFL1717	-	-	M5EFU3717	M5EFL3717
.017x.025	M5TFU1725	M5TFL1725	M5EFU1725	M5EFL1725	M5BF3U1725	M5BF3L1725	M5EFU3725	M5EFL3725
.018x.018	M5TFU1818	M5TFL1818	M5EFU1818	M5EFL1818	M5BF3U1818	M5BF3L1818	M5EFU3818	M5EFL3818
.018x.025	M5TFU1825	M5TFL1825	M5EFU1825	M5EFL1825	M5BF3U1825	M5BF3L1825	M5EFU3825	M5EFL3825
.019x.025	M5TFU1925	M5TFL1925	M5EFU1925	M5EFL1925	M5BF3U1925	M5BF3L1925	M5EFU3925	M5EFL3925
.020x.020	M5TFU2020	M5TFL2020	M5EFU2020	M5EFL2020	M5BF3U2020	M5BF3L2020	M5EFU3020	M5EFL3020
.021x.025	M5TFU2125	M5TFL2125	M5EFU2125	M5EFL2125	M5BF3U2125	M5BF3L2125	M5EFU3125	M5EFL3125

verpakt per 25 draden/emballé par 25 fils



S3 STAINLESS STEEL Archwires

SIZE	TRUEFORM™ I		EUROPA™ I		BIOFORM III		EUROPA™ II (Damon Comp.)	
	UPPER	LOWER	UPPER	LOWER	UPPER	LOWER	UPPER	LOWER
.012	S3TFU012	S3TFL012	S3EFU012	S3EFL012	S3BF3U012	S3BF3L012	S3EFU112	S3EFL112
.014	S3TFU014	S3TFL014	S3EFU014	S3EFL014	S3BF3U014	S3BF3L014	S3EFU114	S3EFL114
.016	S3TFU016	S3TFL016	S3EFU016	S3EFL016	S3BF3U016	S3BF3L016	S3EFU116	S3EFL116
.018	S3TFU018	S3TFL018	S3EFU018	S3EFL018	S3BF3U018	S3BF3L018	S3EFU118	S3EFL118
.020	S3TFU020	S3TFL020	S3EFU020	S3EFL020	S3BF3U020	S3BF3L020	S3EFU120	S3EFL120
.016x.016	S3TFU1616	S3TFL1616	S3EFU1616	S3EFL1616	S3BF3U1616	S3BF3L1616	S3EFU3616	S3EFL3616
.016x.022	S3TFU1622	S3TFL1622	S3EFU1622	S3EFL1622	S3BF3U1622	S3BF3L1622	S3EFU3622	S3EFL3622
.016x.025	S3TFU1625	-	S3EFU1625	S3EFL1625	-	-	S3EFU3625	S3EFL3625
.017x.017	S3TFU1717	S3TFL1717	S3EFU1717	S3EFL1717	S3BF3U1717	S3BF3L1717	S3EFU3717	S3EFL3717
.017x.022	S3TFU1722	S3TFL1722	S3EFU1722	S3EFL1722	S3BF3U1722	S3BF3L1722	S3EFU3722	S3EFL3722
.017x.025	S3TFU1725	S3TFL1725	S3EFU1725	S3EFL1725	S3BF3U1725	S3BF3L1725	S3EFU3725	S3EFL3725
.018x.018	S3TFU1818	S3TFL1818	S3EFU1818	S3EFL1818	S3BF3U1818	S3BF3L1818	S3EFU3818	S3EFL3818
.018x.022	S3TFU1822	S3TFL1822	S3EFU1822	S3EFL1822	S3BF3U1822	S3BF3L1822	S3EFU3822	S3EFL3822
.018x.025	S3TFU1825	S3TFL1825	S3EFU1825	S3EFL1825	S3BF3U1825	S3BF3L1825	S3EFU3825	S3EFL3825
.019x.019	S3TFU1919	S3TFL1919	S3EFU1919	S3EFL1919	S3BF3U1919	S3BF3L1919	S3EFU3919	S3EFL3919
.019x.025	S3TFU1925	S3TFL1925	S3EFU1925	S3EFL1925	S3BF3U1925	S3BF3L1925	S3EFU3925	S3EFL3925
.020x.020	S3TFU2020	S3TFL2020	S3EFU2020	S3EFL2020	S3BF3U2020	S3BF3L2020	S3EFU3020	S3EFL3020
.021x.025	S3TFU2125	S3TFL2125	S3EFU2125	S3EFL2125	S3BF3U2125	S3BF3L2125	S3EFU3125	S3EFL3125

verpakt per 25 draden/emballé par 25 fils



XR1 HEATH-TREATED STAINLESS STEEL Archwires

XR1™ is een roestvast staal met een unieke warmtebehandeling. De draad is spanningsvrij en heeft een hogere veerkracht dan een gewone SS draad waardoor de mechanica beter is.

XR1™ est un acier inoxydable avec un traitement thermique unique. Le fil est sans tension et a une endurance, résilience supérieure à celle d'un fil en acier ordinaire ce qui améliore la mécanique.

SIZE	TRUEFORM™ I		EUROPA™ I		BIOFORM III		EUROPA™ II (Damon Comp.)	
	UPPER	LOWER	UPPER	LOWER	UPPER	LOWER	UPPER	LOWER
.012	XRTFU012	XRTFL012	XREFU012	XREFL012	XRBF3U012	XRBF3L012	XREFU112	XREFL112
.014	XRTFU014	XRTFL014	XREFU014	XREFL014	XRBF3U014	XRBF3L014	XREFU114	XREFL114
.016	XRTFU016	XRTFL016	XREFU016	XREFL016	XRBF3U016	XRBF3L016	XREFU116	XREFL116
.018	XRTFU018	XRTFL018	XREFU018	XREFL018	XRBF3U018	XRBF3L018	XREFU118	XREFL118
.020	XRTFU020	XRTFL020	XREFU020	XREFL020	XRBF3U020	XRBF3L020	XREFU120	XREFL120
.016x.016	XRTFU1616	XRTFL1616	XREFU1616	XREFL1616	XRBF3U1616	XRBF3L1616	XREFU3616	XREFL3616
.016x.022	XRTFU1622	XRTFL1622	XREFU1622	XREFL1622	XRBF3U1622	XRBF3L1622	XREFU3622	XREFL3622
.016x.025	-	-	XREFU1625	XREFL1625	-	-	XREFU3625	XREFL3625
.017x.017	XRTFU1717	XRTFL1717	XREFU1717	XREFL1717	XRBF3U1717	XRBF3L1717	XREFU3717	XREFL3717
.017x.022	XRTFU1722	XRTFL1722	XREFU1722	XREFL1722	XRBF3U1722	XRBF3L1722	XREFU3722	XREFL3722
.017x.025	XRTFU1725	XRTFL1725	XREFU1725	XREFL1725	XRBF3U1725	XRBF3L1725	XREFU3725	XREFL3725
.018x.018	-	XRTFL1818	XREFU1818	XREFL1818	XRBF3U1818	XRBF3L1818	XREFU3818	XREFL3818
.018x.022	XRTFU1822	XRTFL1822	XREFU1822	XREFL1822	XRBF3U1822	XRBF3L1822	XREFU3822	XREFL3822
.018x.025	XRTFU1825	XRTFL1825	XREFU1825	XREFL1825	XRBF3U1825	XRBF3L1825	XREFU3825	XREFL3825
.019x.025	XRTFU1925	XRTFL1925	XREFU1925	XREFL1925	XRBF3U1925	XRBF3L1925	XREFU3925	XREFL3925
.020x.020	XRTFU2020	XRTFL2020	XREFU2020	XREFL2020	XRBF3U2020	XRBF3L2020	XREFU3020	XREFL3020
.021x.025	XRTFU2125	XRTFL2125	XREFU2125	XREFL2125	XRBF3U2125	XRBF3L2125	XREFU3125	XREFL3125

verpakt per 25 draden/emballé par 25 fils



TITANMOLY TITANIUM MOLYBDENUM Archwires



SIZE	TRUEFORM™ I		EUROPA™ I		BIOFORM III		EUROPA™ II (Damon Comp.)	
	UPPER	LOWER	UPPER	LOWER	UPPER	LOWER	UPPER	LOWER
.016	B3TFU016	B3TFL016	-	-	-	-	-	-
.018	B3TFU018	B3TFL018	-	-	-	-	-	-
.016x.016	B3TFU1616	B3TFL1616	-	-	-	-	-	-
.016x.022	B3TFU1622	B3TFL1622	B3EFU1622	B3EFL1622	B3BF3U1622	B3BF3L1622	B3EFU3622	B3EFL3622
.017x.025	B3TFU1725	B3TFL1725	B3EFU1725	B3EFL1725	B3BF3U1725	B3BF3L1725	B3EFU3725	B3EFL3725
.0175x.0175	B3TFU7575	B3TFL7575	-	-	-	-	-	-
.018x.025	B3TFU1825	B3TFL1825	-	-	-	-	-	-
.019x.025	B3TFU1925	B3TFL1925	B3EFU1925	B3EFL1925	B3BF3U1925	B3BF3L1925	B3EFU3925	B3EFL3925
.020x.020	-	-	-	-	-	-	B3EFU3020	B3EFL3020
.021x.025	B3TFU2125	B3TFL2125	-	-	-	-	B3EFU3125	B3EFL3125

verpakt per 10 draden/emballé par 10 fils

Draden/Fils

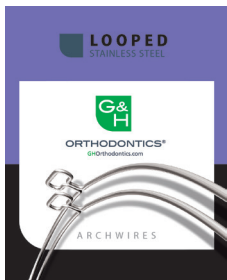

STAINLESS STEEL KEYHOLE & T-LOOP Archwires



	KEYHOLE 2-LOOP	KEYHOLE 4-LOOP	T-LOOP
	TrueForm		
	.019 x .025	.019 x .025	.019 x .025
22 mm	KHTF2192522	KHTF4192522	-
24 mm	KHTF2192524	KHTF4192524	TLTF192524
26 mm	KHTF2192526	KHTF4192526	TLTF192526
28 mm	KHTF2192528	KHTF4192528	TLTF192528
30 mm	KHTF2192530	KHTF4192530	TLTF192530
32 mm	KHTF2192532	KHTF4192532	TLTF192532
34 mm	KHTF2192534	KHTF4192534	TLTF192534
36 mm	KHTF2192536	KHTF4192536	TLTF192536
38 mm	KHTF2192538	KHTF4192538	TLTF192538
40 mm	KHTF2192540	KHTF4192540	TLTF192540
42 mm	KHTF2192542	KHTF4192542	TLTF192542
44 mm	KHTF2192544	KHTF4192544	TLTF192544
46 mm			TLTF192546
Kit 100 pcs	KHTFK21925	KHTFK41925	TLTFK

Ook verkrijgbaar in .016x.022 en .017x.25.
Verpakt per 10

Aussi disponible en .016x.022 et .017x.25.
Emballé par 10

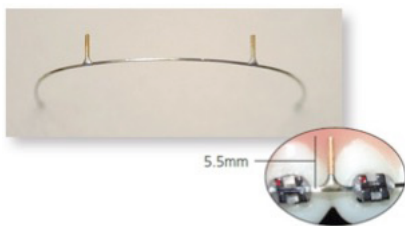

STRAIGHT POST Archwires

SIZE	TRUEFORM™ I	EUROPA™ I	EUROPA™ II
.016	PSTF016*	PSEF016*	-
.018	PSTF018*	PSEF018*	-
.020	PSTF020*	PSEF020*	-
.016x.016	PSTF1616*	PSEF1616*	-
.016x.022	PSTF1622*	PSEF1622*	-
.016x.025	-	-	PSEF3625*
.017x.025	PSTF1725*	PSEF1725*	PSEF3725*
.018x.025	PSTF1825*	PSEF1825*	-
.019x.025	PSTF1925*	PSEF1925*	PSEF3925*
.020x.020	PSTF2020*	PSEF2020*	-
.021x.025	PSTF2125*	PSEF2125*	PSEF3125*

* Voeg de gewenste millimeter toe,
verkrijgbaar in stappen van 2mm

- Upper van 34 tot 44 mm
- Lower van 22 tot 32 mm
- Verpakt per 10 draden

* Insérez le millimètre souhaité,
disponible par pas de 2mm

- Upper de 34 à 44 mm
- Lower de 22 à 32 mm
- Emballé par 10 fils

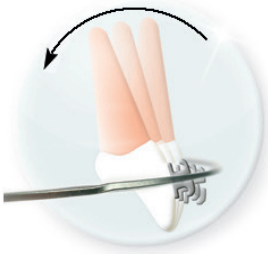

G4 & DYB™ PRE-TORQUED ARCHWIRE SERIES

NICKEL TITANIUM

SIZE	TRUEFORM™ I			EUROPA™ II		
	mm span			mm span		
.017x.025	PTTF172528	28mm	LOWER	PTEF372528	28mm	LOWER
	PTTF172534	34mm	UPPER	PTEF372534	34mm	UPPER
	PTTF172538	38mm	UPPER	PTEF372538	38mm	UPPER
.019x.025	PTTF192528	28mm	LOWER	PTEF392528	28mm	LOWER
	PTTF192534	34mm	UPPER	PTEF392534	34mm	UPPER
	PTTF192538	38mm	UPPER	PTEF392538	38mm	UPPER
.021x.025	PTTF212528	28mm	LOWER	-	-	-
	PTTF212534	34mm	UPPER	-	-	-
	PTTF212538	38mm	UPPER	-	-	-

verpakt per 5 draden/emballé par 5 fils

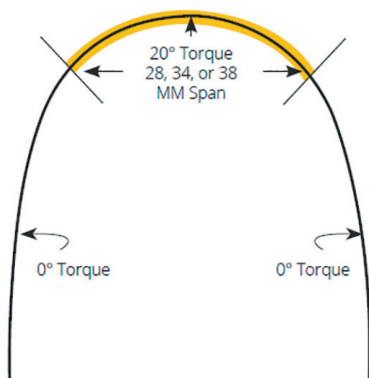

One end color coded:

- Red** = 28 mm (Lower)
- Blue** = 34 mm (Upper)
- Black** = 38 mm (Upper)

Color Mark Orientation:

- As applied to the upper arch - 34 & 38 mm
- Engage color to patient right for lingual root torque
- Engage color to patient left for labial root torque
- Reverse this orientation for lower arch (28 mm) applications

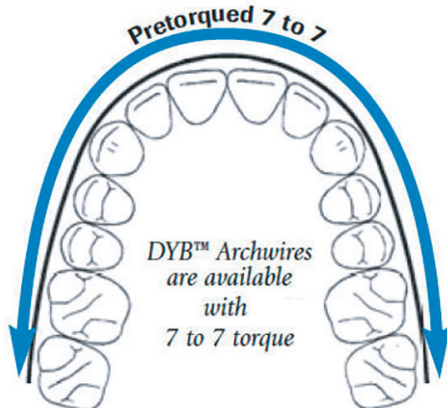

EF2 - S304 STAINLESS STEEL - DYB™

Dimension	15° Torque
.017x.025	S3EFU3725TQ
.019x.025	S3EFU3925TQ
.020x.020	S3EFU3020TQ

Verpakt per 10 draden / Emballé par 10 fils

EF2 - TITANMOLY™ TITANIUM MOLYBDENUM - DYB™

Dimension	20° Torque
.017x.025	B3EFU3725TQ
.019x.025	B3EFU3925TQ
.020x.020	B3EFU3020TQ

Verpakt per 10 draden / Emballé par 10 fils



G4™ & M5™ REVERSE CURVE NiTi Archwires

SIZE	REVERSE CURVE I				REVERSE CURVE III			
	G4™ NiTi		M5™ Thermal Copper NiTi		G4™ NiTi		M5™ Thermal Copper NiTi	
	UPPER	LOWER	UPPER	LOWER	UPPER	LOWER	UPPER	LOWER
.012	G4RCU012	G4RCL012	M5RCU012	M5RCL012	G4RCU3012	G4RCL3012	M5RCU3012	M5RCL3012
.014	G4RCU014	G4RCL014	M5RCU014	M5RCL014	G4RCU3014	G4RCL3014	M5RCU3014	M5RCL3014
.016	G4RCU016	G4RCL016	M5RCU016	M5RCL016	G4RCU3016	G4RCL3016	M5RCU3016	M5RCL3016
.018	G4RCU018	G4RCL018	M5RCU018	M5RCL018	G4RCU3018	G4RCL3018	M5RCU3018	M5RCL3018
.020	G4RCU020	G4RCL020	M5RCU020	M5RCL020	G4RCU3020	G4RCL3020	M5RCU3020	M5RCL3020
.016x.016	G4RCU1616	G4RCL1616	M5RCU1616	M5RCL1616	G4RCU31616	G4RCL31616	M5RCU31616	M5RCL31616
.016x.022	G4RCU1622	G4RCL1622	M5RCU1622	M5RCL1622	G4RCU31622	G4RCL31622	M5RCU31622	M5RCL31622
.017x.017	G4RCU1717	G4RCL1717	M5RCU1717	M5RCL1717	-	-	-	-
.017x.025	G4RCU1725	G4RCL1725	M5RCU1725	M5RCL1725	G4RCU31725	G4RCL31725	M5RCU31725	M5RCL31725
.018x.018	G4RCU1818	G4RCL1818	M5RCU1818	M5RCL1818	G4RCU31818	G4RCL31818	M5RCU31818	M5RCL31818
.018x.025	G4RCU1825	G4RCL1825	M5RCU1825	M5RCL1825	G4RCU31825	G4RCL31825	M5RCU31825	M5RCL31825
.019x.025	G4RCU1925	G4RCL1925	M5RCU1925	M5RCL1925	G4RCU31925	G4RCL31925	M5RCU31925	M5RCL31925
.020x.020	G4RCU2020	G4RCL2020	M5RCU2020	M5RCL2020	G4RCU32020	G4RCL32020	M5RCU32020	M5RCL32020
.021x.025	G4RCU2125	G4RCL2125	M5RCU2125	M5RCL2125	G4RCU32125	G4RCL32125	M5RCU32125	M5RCL32125

verpakt per 10 draden/emballé par 10 fils

Europa™II Reverse Curve		
Size	UPPER	LOWER
.013	G4RCD113	-
.014	G4RCD114	-
.016	G4RCD116	-
.018	G4RCD118	-
.014x.025	G4RCD3425	G4RCM3425
.016x.016	G4RCD3616	-
.016x.025	G4RCD3625	-
.017x.017	G4RCD3717	-
.017x.025	G4RCD3725	-
.018x.018	G4RCD3818	-
.018x.025	G4RCD3825	G4RCM3825
.019x.025	G4RCD3925	-
.020x.020	G4RCD3020	-

verpakt per 10 draden/emballé par 10 fils

RC I

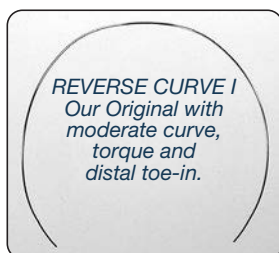

RC III

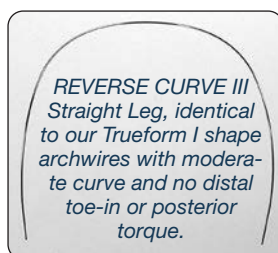

EUROPA™II RC



EUROPA™II REVERSE CURVE is also available with preloaded crimpable stops. For pre-loaded Crimpable Stops add "CB" to the end of part number.



MULTI-STRAND STAINLESS STEEL

Archwires

THREE STRAND (Twisted)

SIZE	TRUEFORM™ I		STANDARD FORM		14" Straight Lengths	30' Spools
	UPPER	LOWER	UPPER	LOWER		
.0155	-	-	-	-	MS3155	SST3155
.0175	-	-	-	-	MS3175	SST3175
.0195	-	-	-	-	MS3195	SST3195
.0215	-	-	-	-	MS3215	SST3215
.016x.016	CTFU1616	CTFL1616	CSFU1616	CSFL1616	MS3616	-
.016x.022	CTFU1622	CTFL1622	CSFU1622	CSFL1622	MS3622	-
.017x.025	CTFU1725	CTFL1725	CSFU1725	CSFL1725	MS3725	-
.018x.025	CTFU1825	CTFL1825	CSFU1825	CSFL1825	MS3825	-
.019x.025	CTFU1925	CTFL1925	CSFU1925	CSFL1925	MS3925	-

verpakt per 25 draden/emballé par 25 fils

SIX STRAND (Coaxial)

SIZE	14" Straight Lengths	30' Spools
.0155	MS6155	SST6155
.0175	MS6175	260-652
.0195	MS6195	260-654
.0215	MS6215	SST6215

verpakt per 25 draden/emballé par 25 fils

EIGHT STRAND (Woven)

SIZE	TRUEFORM™ I		STANDARD FORM	
	UPPER	LOWER	UPPER	LOWER
.016x.016	CTFU8616	CTFL8616	CSFU8616	CSFL8616
.016x.022	CTFU8622	CTFL8622	CSFU8622	CSFL8622
.017x.025	CTFU8725	CTFL8725	CSFU8725	CSFL8725
.018x.025	CTFU8825	CTFL8825	CSFU8825	CSFL8825
.019x.025	CTFU8925	CTFL8925	CSFU8925	CSFL8925
.021x.025	CTFU8125	CTFL8125	CSFU8125	CSFL8125

verpakt per 25 draden/emballé par 25 fils

STAINLESS STEEL LIGATURE TIES

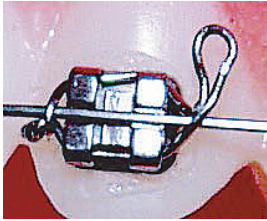

G&H® KOBY TIES

100/pkg.			
Long		Short	
-	-	.012	270-006
.012	270-002	.014	270-007
.014	270-004	.014	-



STAINLESS STEEL LIGATURE TIES Preformed in dead soft temper.

Long		
.010	(1,000/pkg.)	270-010
.012	(1,000/pkg.)	270-014



PRE-CUT LIGATURE TIES

.008	Standard (500/pkg.) Applicable for lingual bracket engagement	SLT008
.010	Standard (500/pkg.)	270-016

CRIMPABLE MICRO-STOPS

- 2mm long - 50/pack
- Small .012" to .018" **CSTOPSM**
- Large .020" to .020"x.020" **CSTOPLG**



AUSTRALIAN WIRE



AUSTRALIAN WIRE

25" Spool	Regular	Regular+	Special	Special+
.014	229-104	229-204	229-304	229-404
.016	229-105	229-205	229-305	229-405
.018	229-106	229-206	229-306	229-406
.020	229-107	229-207	229-307	229-407

QUADHELIX Single packed

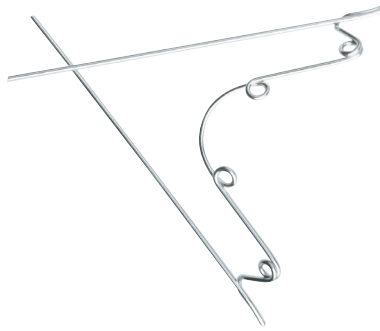

QUADHELIX STAINLESS STEEL

Description	P/N
Size 1, straight retention	68-0021-000
Size 2, straight retention	68-0022-000
Size 3, straight retention	68-0023-000
Size 1, curved retention	68-0041-000
Size 2, curved retention	68-0042-000
Size 3, curved retention	68-0043-000

QUADHELIX BIOALLOY

Description	P/N
Size 1, straight retention	68-0011-000
Size 2, straight retention	68-0012-000
Size 3, straight retention	68-0013-000
Size 1, curved retention	68-0031-000
Size 2, curved retention	68-0032-000
Size 3, curved retention	68-0033-000

LINGUAL RETENTION WIRES

STAINLESS STEEL ORTHO-FLEXTECH

270-108SS



30" GOLD ORTHO-FLEXTECH

270-108



STRAIGHT 8

- Standard version **DB22-0458**
- Nickel free **DB22-0460**
- Sold in 6" length packs of 10



WAXED FLOSS

Johnson&Johnson
200m

100000045



PENTAFLEX

Pentaflex is a rectangular coaxial wire (five strands twisted around a central core), straight length or preformed, 10 per box.



Dimension	P/N	A	
		P/N	
	14" Straight Lengths	Maxillary	Mandibular
.0155"	78-LP00-0155	78-APU0-0016	78-APL0-0016
.0175"	78-LP00-0175	78-APU0-0175	78-APL0-0175
.0195"	78-LP00-0195	—	—
.0215"	78-LP00-0215	—	—

ARCHMARKER

800-446

Thick wax tips upon sturdy, wooden dowels to provide precise marking, high visibility and superior adhesion. Disposable to prevent cross contamination. 100 per bag



BAB2

270-107





RHODIUM Archwires



INITIALLOY Aesthetic Light Forces

Dimension	A		C	
	Maxillary	Mandibular	Maxillary	Mandibular
.014"	76-A1U0-0014	76-A1L0-0014	76-C1U0-0014	76-C1L0-0014
.016"	76-A1U0-0016	76-A1L0-0016	76-C1U0-0016	76-C1L0-0016
.018"	76-A1U0-0018	76-A1L0-0018	76-C1U0-0018	76-C1L0-0018

INITIALLOY Aesthetic Medium Forces

Dimension	A		C	
	Maxillary	Mandibular	Maxillary	Mandibular
.014"	76-A2U0-0014	76-A2L0-0014	76-C2U0-0014	76-C2L0-0014
.016"	76-A2U0-0016	76-A2L0-0016	76-C2U0-0016	76-C2L0-0016
.018"	76-A2U0-0018	76-A2L0-0018	76-C2U0-0018	76-C2L0-0018

verpakt per 10 draden/emballé par 10 fils

BIO-ACTIVE Aesthetic Archwires

Dimension	A		C		D
	Maxillary	Mandibular	Maxillary	Mandibular	Universal
.014"x.025"	-	-	-	-	74-D000-1425
.016"x.016"	74-A0U0-1616	74-A0L0-1616	-	-	-
.016"x.022"	74-A0U0-1622	74-A0L0-1622	74-C0U0-1622	74-C0L0-1622	74-D000-1622
.018"x.018"	74-A0U0-1818	74-A0L0-1818	74-C0U0-1818	74-C0L0-1818	-
.018"x.025"	-	-	-	-	74-D000-1825
.019"x.025"	74-A0U0-1925	74-A0L0-1925	74-C0U0-1925	74-C0L0-1925	-
.020"x.020"	74-A0U0-2020	74-A0L0-2020	74-C0U0-2020	74-C0L0-2020	-

BIO-ACTIVE Aesthetic Archwires LIGHT

Dimension	A		C		D
	Maxillary	Mandibular	Maxillary	Mandibular	Universal
.013"	-	-	-	-	74-D100-0013
.014"	-	-	-	-	74-D100-0014
.016"	-	-	-	-	74-D100-0016
.014"x.025"	-	-	-	-	74-D100-1425
.016"x.016"	-	-	-	-	74-D100-1616
.016"x.022"	-	-	-	-	74-D100-1622
.017"x.025"	-	-	-	-	74-D100-1725
.018"x.018"	74-A1U0-1818	74-A1L0-1818	74-C1U0-1818	74-C1L0-1818	74-D100-1818
.018"x.025"	-	-	-	-	74-D100-1825
.019"x.025"	-	-	-	-	74-D100-1925
.020"x.020"	74-A1U0-2020	74-A1L0-2020	74-C1U0-2020	74-C1L0-2020	74-D100-2020

verpakt per 10 draden/emballé par 10 fils



STAINLESS STEEL Aesthetic Archwires

Dimension	A	
	Maxillary	Mandibular
.014"	79-A2U0-0014	79-A2L0-0014
.016"	79-A2U0-0016	79-A2L0-0016
.016"x.016"	79-A2U0-1616	79-A2L0-1616
.016"x.022"	79-A2U0-1622	79-A2L0-1622
.017"x.025"	79-A2U0-1725	79-A2L0-1725
.019"x.025"	79-A2U0-1925	79-A2L0-1925

verpakt per 10 draden/emballé par 10 fils

Draden/Fils

AESTHETIC WIRES



ALBAFLEX IVORY SPACER

The ivory-coloured coating Alfablex provides a discreet solution for stainless steel archwires, while preserving their mechanical properties.

	P/N
.036" Packed by 3 in length of 180mm	2099-SPA-36X55W-T1

PREFORMED Short, ivory-coloured (Pack of 100)

Description	P/N
.011" Ivory coloured	67-0240-0011
.012" Tooth color	67-0140-0012

PREFORMED Long, ivory-coloured (Pack of 100)

Description	P/N
.011" Ivory coloured	67-0140-0011

G4™ TOOTH-COLORED NICKEL TITANIUM ARCHWIRES

SIZE	MBT ² OVOID		MBT ² TAPERED		DAMON [®] -COMPATIBLE	
	EUROPA™ I		TRUEFORM I		EUROPA™ II	
	UPPER	LOWER	UPPER	LOWER	UPPER	LOWER
.012	G4EFU012T	G4EFL012T	G4TFU012T	G4TFL012T	G4EFU112T	G4EFL112T
.014	G4EFU014T	G4EFL014T	G4TFU014T	G4TFL014T	G4EFU114T	G4EFL114T
.016	G4EFU016T	G4EFL016T	G4TFU016T	G4TFL016T	G4EFU116T	G4EFL116T
.018	G4EFU018T	G4EFL018T	G4TFU018T	G4TFL018T	G4EFU118T	G4EFL118T
.020	G4EFU020T	G4EFL020T	G4TFU020T	G4TFL020T	G4EFU120T	G4EFL120T
.016x.022	G4EFU1622T	G4EFL1622T	G4TFU1622T	G4TFL1622T	G4EFU3622T	G4EFL3622T
.017x.025	G4EFU1725T	G4EFL1725T	G4TFU1725T	G4TFL1725T	G4EFU3725T	G4EFL3725T
.018x.018	G4EFU1818T	G4EFL1818T	G4TFU1818T	G4TFL1818T	G4EFU3818T	G4EFL3818T
.018x.025	G4EFU1825T	G4EFL1825T	G4TFU1825T	G4TFL1825T	G4EFU3825T	G4EFL3825T
.019x.025	G4EFU1925T	G4EFL1925T	G4TFU1925T	G4TFL1925T	G4EFU3925T	G4EFL3925T
.020x.020	G4EFU2020T	G4EFL2020T	G4TFU2020T	G4TFL2020T	G4EFU3020T	G4EFL3020T
.021x.025	G4EFU2125T	G4EFL2125T	G4TFU2125T	G4TFL2125T	G4EFU3125T	G4EFL3125T

verpakt per 10 draden/emballé par 10 fils



TOOTH-COLORED REVERSE CURVE G4™ NITI

SIZE	REVERSE CURVE I	
	UPPER	LOWER
.012	G4RCU012T	G4RCL012T
.014	G4RCU014T	G4RCL014T
.016	G4RCU016T	G4RCL016T
.018	G4RCU018T	G4RCL018T
.020	G4RCU020T	G4RCL020T
.016x.022	G4RCU1622T	G4RCL1622T
.017x.025	G4RCU1725T	G4RCL1725T
.018x.018	G4RCU1818T	G4RCL1818T
.018x.025	G4RCU1825T	G4RCL1825T
.019x.025	G4RCU1925T	G4RCL1925T
.020x.020	G4RCU2020T	G4RCL2020T
.021x.025	G4RCU2125T	G4RCL2125T

verpakt per 10 draden/emballé par 10 fils

Draden/Fils



AESTHETIC WIRES

S3 TOOTH-COLORED STAINLESS STEEL ARCHWIRES

SIZE	MBT ² OVOID		MBT ² SQUARE		DAMON [®] -COMPATIBLE	
	EUROPA [™] I		TRUEFORM [™] I		EUROPA [™] II	
	UPPER	LOWER	UPPER	LOWER	UPPER	LOWER
.014	S3EFU014T	S3EFL014T	S3TFU014T	S3TFL014T	S3EFU114T	S3EFL114T
.016	S3EFU016T	S3EFL016T	S3TFU016T	S3TFL016T	S3EFU116T	S3EFL116T
.018	S3EFU018T	S3EFL018T	S3TFU018T	S3TFL018T	S3EFU118T	S3EFL118T
.020	S3EFU020T	S3EFL020T	S3TFU020T	S3TFL020T	S3EFU120T	S3EFL120T
.016x.022	S3EFU1622T	S3EFL1622T	S3TFU1622T	S3TFL1622T	S3EFU3622T	S3EFL3622T
.017x.025	S3EFU1725T	S3EFL1725T	S3TFU1725T	S3TFL1725T	S3EFU3725T	S3EFL3725T
.018x.018	S3EFU1818T	S3EFL1818T	S3TFU1818T	S3TFL1818T	S3EFU3818T	S3EFL3818T
.018x.025	S3EFU1825T	S3EFL1825T	S3TFU1825T	S3TFL1825T	S3EFU3825T	S3EFL3825T
.019x.025	S3EFU1925T	S3EFL1925T	S3TFU1925T	S3TFL1925T	S3EFU3925T	S3EFL3925T
.020x.020	S3EFU2020T	S3EFL2020T	S3TFU2020T	S3TFL2020T	S3EFU3020T	S3EFL3020T
.021x.025	S3EFU2125T	S3EFL2125T	S3TFU2125T	S3TFL2125T	S3EFU3125T	S3EFL3125T

verpakt per 25 draden/emballé par 25 fils

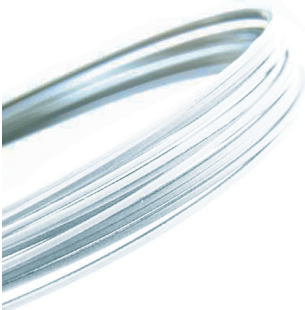

The Nano Coated wires are complimentary to any ceramic or sapphire bracket system with its natural tooth shade color. It has reduced friction with the special nano coating. The wire has high flexibility and resiliency allowing consistent forces. Lastly, with the coating the wire's diameter does not change.

NANO COATED ARCHWIRES

10 pk SIZE	NITINOL		STAINLESS STEEL	
	UPPER	LOWER	UPPER	LOWER
.012	226-001N	226-001N	-	-
.014	226-002N	226-003N	-	-
.016	226-005N	226-005N	250-141N	250-151N
.018	226-006N	226-007N	250-142N	250-152N
.020	226-008N	226-009N	-	-
.016x.016	226-010N	226-011N	-	-
.016x.022	226-012N	226-013N	250-145N	250-155N
.017x.025	226-014N	226-015N	250-146N	250-156N
.018x.025	226-016N	226-017N	-	-
.019x.025	226-018N	226-019N	-	-

verpakt per 10 draden/emballé par 10 fils





Elastieken/ Élastiques



ORCHESTRA INTRA & EXTRAORAL ELASTICS

Force/Size	2.5 oz (70,88 g)	4.0 oz (113,40 g)	6.0 oz (170,10 g)	EXTRA-ORAL 8,5 oz (240,98g)
3 mm (1/8")	85-0321-0000 Harp	85-0331-0000 Xylophone	85-0341-0000 Tuba	-
4 mm (3/16")	85-0421-0000 Tambourine	85-0431-0000 Piano	85-0441-0000 Trumpet	85-0461-0000 Trombone
4 mm (3/16")	-	85-0430-0000 Jazz Latex Free	85-0440-0000 Rock-n-Roll Latex Free	-
6 mm (1/4")	85-0621-0000 Oboe	85-0631-0000 Flute	85-0641-0000 Baritone	85-0661-0000 French Horn
6 mm (1/4")	-	85-0630-0000 Hip-Hop Latex Free	85-0640-0000 Classical Latex Free	-
8 mm (5/16")	85-0821-0000 Cello	85-0831-0000 Clarinet	85-0841-0000 Saxophone	85-0861-0000 Guitar
10 mm (3/8")	85-1021-0000 Cymbals	85-1031-0000 Tympani	-	85-1061-0000 Violin

EXTREME ELASTICS



Force/Size	Light 3.5 oz	Medium 4.5 oz	Heavy 6.0 oz
3,2 mm (1/8")	M931-01 Kayaking	M931-06 Surfing	M931-11 Jet Skiing
4,8mm (3/16")	M931-02 Motorcross	M931-07 Skiing	M931-12 Bungeejumping
6,4mm (1/4")	M931-03 Rock Climbing	M931-08 Skydiving	M931-13 Snowmobiling
7,9mm (5/16")	M931-04 Skateboarding	M931-09 BMX Freestyle	M931-14 Snowboarding
9,5mm (3/8")	M931-05 Water Skiing	M931-10 Windsurfing	M931-15 Wakeboarding

ELASTIC ATTACHER



100/pkg
Assorted colors **800-026**

ELASTIC STORAGE KEY RINGS



50/pkg.
Neon assorted **ESC050**
Basic assorted **ESC150**

COLOR CHART for elastomeric Ties & Chain

CLEAR	GLOW	PEARL	METALLIC RED	RUBY RED	ORANGE
WHITE	GLOW BLUE	PEARL GREEN	METALLIC GOLD	MAROON	FLUORESCENT ORANGE
BLACK	TOOTH	PEARL BLUE	METALLIC PURPLE	LAVENDER	FUCHSIA
GRAY	NEON GREEN	GREEN	TRANSPARENT GREEN	TURQUOISE	PINK
SMOKE	DEEP SKY BLUE	NAVY BLUE	METALLIC BLUE	ROYAL BLUE	FLUORESCENT PINK
METALLIC SILVER	LIGHT SKY BLUE	YELLOW			



LIGITIEBOOK

- 20 ligaturen per stick
- 50 sticks verpakking
- 1000 ligaturen per verpakking

- 20 ligatures par bâtonnet
- paquet de 50 bâtonnets
- 1000 ligatures par paquet

DYNA-LINK™ ELASTOMERIC CHAIN Latex-Free

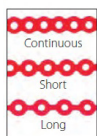

- 1 rol chain 4,5m, .0255" dikte
- 1 rouleau de chaînette 4,5m, .0255" d'épaisseur

		Select-Tie	Dyna-Link™ Chain		
					
			Continuous	Short	Long
	Pearl	OCSLPL	CDLPL	SDLPL	LDLPL
	Glow	OCSLGL	CDLGW	SDLGW	LDLGW
	Neon Green	OCSLNG	CDLNG	SDLNG	LDLNG
	Pearl Green	OCSLPG	CDLPG	SDLPG	LDLPG
	Glow Blue	OCSLGB	CDLGB	SDLGB	LDLGB
	Pearl Blue	OCSLPB	CDLPB	SDLPB	LDLPB
	Lavender	OCSLLV	CDLLV	SDLLV	LDLLV
	Maroon	OCSLMA	CDLMA	SDLMA	LDLMA
	Clear	OCSLCL	CDLCL1	SDLCL1	LDLCL1
	Gray	OCSLGY	CDLGY	SDLGY	LDLGY
	Metallic Silver	OCSLMS	CDLSV	SDLSV	LDLSV
	Metallic Gold	OCSLGD	CDLGD	SDLGD	LDLGD
	Metallic Purple	OCSLPP	CDLPP	SDLPP	LDLPP
	Metallic Red	OCSLMR	CDLMR	SDLMR	LDLMR
	Metallic Blue	OCSLMB	CDLMB	SDLMB	LDLMB
	Royal Blue	OCSLRB	CDLRB	SDLRB	LDLRB
	Lt. Sky Blue	OCSLLS	CDLLS	SDLLS	LDLLS
	Deep Sky Blue	OCSLDS	CDLDS	SDLDS	LDLDS
	Navy Blue	OCSLNB	CDLNB	SDLNB	LDLNB
	Green	OCSLGR	CDLGR	SDLGR	LDLGR
	Transp. Green	OCSLTG	CDLTG	SDLTG	LDLTG
	Ruby Red	OCSLRR	CDLRR	SDLRR	LDLRR
	Turquoise	OCSLTQ	CDLTQ	SDLTQ	LDLTQ
	White	OCSLWT	CDLWT	SDLWT	LDLWT
	Fuchsia	OCSLFU	CDLFU	SDLFU	LDLFU
	Black	OCSLBK	CDLBK	SDLBK	LDLBK
	Orange	OCSLOR	CDLOR	SDLOR	LDLOR
	Fluor. Orange	OCSLFO	CDLFO	SDLFO	LDLFO
	Yellow	OCSLYW	CDLYW	SDLYW	LDLYW
	Pink	OCSLPK	CDLPK	SDLPK	LDLPK
	Fluor. Pink	OCSLFP	CDLFP	SDLFP	LDLFP
	Tooth	OCSLTC	CDLTC	SDLTC	LDLTC
	Smoke	OCSLSM	CDLSM	SDLSM	LDLSM

ELASTICS LIGATURES



colour
boutique

	Elastic Ligatures	Closed Chain	Open Chain	Open Long Chain
● Red	DB03-3000	DB03-3100	DB03-3200	DB03-3300
● Orange	DB03-3001	DB03-3101	DB03-3201	DB03-3301
● Silver	DB03-3002	DB03-3102	DB03-3202	DB03-3302
● Neon Pink	DB03-3003	DB03-3103	DB03-3203	DB03-3303
● Pink	DB03-3004	-	-	-
● Baby Pink	DB03-3005	DB03-3105	DB03-3205	DB03-3305
● Deep Pink	DB03-3006	DB03-3106	DB03-3206	DB03-3306
● Lavender	DB03-3007	DB03-3107	DB03-3207	DB03-3307
● Neon Green	DB03-3008	DB03-3108	DB03-3208	DB03-3308
● Purple	DB03-3009	DB03-3109	DB03-3209	DB03-3309
● Baby Blue	DB03-3010	-	-	-
● Black	DB03-3011	DB03-3111	DB03-3211	DB03-3311
● Metallic Blue	DB03-3012	DB03-3112	DB03-3212	DB03-3312
● Navy Blue	DB03-3013	DB03-3113	DB03-3213	DB03-3313
● Blue	DB03-3014	DB03-3114	DB03-3214	DB03-3314
● Metallic Purple	DB03-3015	-	-	-
● White	DB03-3016	DB03-3116	DB03-3216	DB03-3316
● Clear	DB03-3017	DB03-3117	DB03-3217	DB03-3317
● Cyan	DB03-3018	DB03-3118	DB03-3218	DB03-3318
● Turquoise	DB03-3019	DB03-3119	DB03-3219	DB03-3319
● Lilac	DB03-3020	DB03-3120	DB03-3220	DB03-3320
● Green	DB03-3021	-	-	-
● Racing Green	DB03-3022	-	-	-
● Aubergine	DB03-3023	-	-	-
● Sky Blue	DB03-3024	-	-	-
● Ice White	DB03-3025	-	-	-
● Mixed pack	DB03-3026	-	-	-
● Yellow	DB03-3027	DB03-3121	DB03-3221	DB03-3321
● Gold	DB03-3028	DB03-3122	DB03-3222	DB03-3322



Elastic ligatures

- 26 ligatures per stick
- 40 sticks verpakking
- 1040 ligaturen per verpakking

- 26 ligatures par bâtonnet
- paquet de 40 bâtonnets
- 1040 ligatures par paquet

Chain

- 1 rol chain 4,5m
- 1 rouleau de chaînette 4,5m



GC ORTHOCHAIN

	Short - 2m	Medium - 2m	Long - 2m
○ Clear	86-1010-000	86-1020-000	86-1030-000
● Grey	86-2010-000	86-2020-000	86-2030-000

ELASTICS

ELASTOMERIC LIGATURE KIT

- Lege kit / Boîte vide: **DB03-L/box**



CHAIN DISPENSER

- 18 spools **700-065**

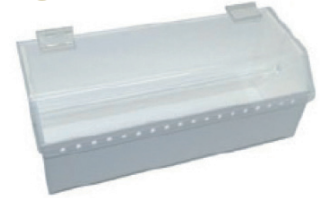

TIES/CHAIN COMBO DISPENSER **700-062**



ELASTOMERIC SEPARATORS

325-302



ELASTOMERIC THREAD & TUBING

- Tube Gray
25 ft. Spool - .025 - **340-210**
- Tube Clear
25 ft. Spool - .025 - **340-205**
- Thread Gray
25 ft. Spool - .025 - **340-110**
- Thread Clear
25 ft. Spool - .025 - **340-105**
- Slip-not Solid - .025
SNTGY025 grey / **SNTCL025** clear



ROTATION WEDGES

100/pkg

- Clear **270-021**
- Grey **270-022**



DENTALASTICS® SEPARATORS

- 1000 pcs - BLUE - **774-200-01**



ARCH SLEEVE PROTECTIVE TUBING

Latex-Free - 10 ft. Per spool - .027" - .027"x.027"

- Grey **340-310**
- Clear **340-305**



SLINGTIES™

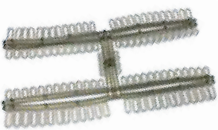

Verpakking / Emballage
- 104 x 6mm Slingties
- 104 x 9mm Slingties™
300-000



De Slingties sluiten de diastemen en verankeren 2 tanden.
Les Slingties ferment le diastème et forme un ancrage avec 2 dents.



De Slingties maken ruimte en brengt de tand naar de draad.
Les Slingties créent de l'espace et amènent la dent vers le fil.

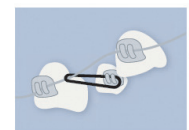

De Slingtie trekt de hoektaand naar de draad.
Le Slingtie tire la canine vers le fil.





Springs & Auxiliaries/ Ressorts & Auxiliaires

INITIALLOY Springs

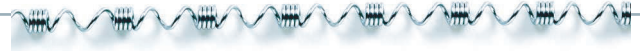

INITIALLOY Stop Wound™ Open Springs

Description	Force	Color	Internal bore	P/N
Extra-Light	50 g	Black	.036"	60-0112-0000
Light	100 g	Blue	.036"	60-0113-0000
Medium	150 g	Yellow	.036"	60-0114-0000
Medium	150 g	Yellow	.045"	60-0114-0045
Heavy	200 g	Red	.036"	60-0115-0000

3 stuks/verpakking - 3 pcs/ emballage



INITIALLOY Open Springs

Description	Force	Color	P/N
Medium	150 g	Yellow	60-0124-0000

10 stuks/verpakking - 10 pcs/emballage



NITI Open Spring (in Spool)

	P/N
INITIALLOY Open Spring in Spool, Medium Force (150 g), .010"x.036"	60-0144-0000
Standard Open Spring in Spool .010" x .030"	60-0140-0013



INITIALLOY Closed Springs

Description	Force	Color	P/N
Light	100 g	Blue	60-0223-0000
Medium	150 g	Yellow	60-0224-0000
Heavy	200 g	Red	60-0225-0000
Incisors Retraction	300 g	White	60-0227-0000

10 stuks/verpakking - 10 pcs/emballage

STAINLESS STEEL Springs



OPEN SPRING (91cm / 3' Spool)





Dimension	P/N
.008"x.022"	61-0140-0082
.010"x.030"	61-0140-0013
.010"x.040"	61-0140-0014

CLOSED SPRING (91cm / 3' Spool)

Dimension	P/N
.008"x.022"	61-0240-0082
.010"x.030"	61-0240-0013



Constant Force NiTi Springs

Item	Force	ID	Wire Size	9mm	12mm
 Extra Light (XL)	50g	1 Hole	.007x.038	226-290	226-295
 Light (L)	100g	2 Holes	.009x.038	226-291	226-296
 Medium (M)	150g	3 Holes	.010x.038	226-292	226-297
 Heavy (H)	200g	4 Holes	.011x.042	226-293	226-298
 Extra Heavy (XH)	250g	5 Holes	.012x.042	226-294	226-299

Constant Force Spring Kit:

*Full kit includes 1 each of: 32mm, 34mm, 36mm, 38mm, and 40mm 5 of each size, 9 mm & 12 mm (50 total) 226-289

5 stuks/verpakking - 5 pcs/emballage



Length	Size	Force	Order Numbers	Extension Measurement Landmarks (mm) / Subsequent Force Values (gms)								
				13mm	15mm	17mm	19mm	22mm	27mm	31mm	36mm	41mm
Extra Short (11mm)	A1	Light (150g)	CCOT45LT	95	125	150	-	-	-	-	-	-
	A2	Medium (200g)	CCOT45MD	130	170	200	-	-	-	-	-	-
	A3	Heavy (250g)	CCOT45HV	150	210	250	-	-	-	-	-	-
Short (13mm)	B1	Light (150g)	CCOT6LT	-	95	120	130	150	-	-	-	-
	B3	Medium (200g)	CCOT6MD	-	125	150	170	200	-	-	-	-
	B3	Heavy (250g)	CCOT6HV	-	150	180	200	250	-	-	-	-
Medium (15mm)	C1	Light (150g)	CCOT9LT	-	-	85	100	110	130	150	-	-
	C2	Medium (200g)	CCOT9MD	-	-	115	140	150	180	200	-	-
	C3	Heavy (250g)	CCOT9HV	-	-	145	165	175	220	250	-	-
Long (17mm)	D1	Light (150g)	CCOT12LT	-	-	-	85	95	110	120	130	150
	D2	Medium (200g)	CCOT12MD	-	-	-	110	125	150	170	190	200
	D3	Heavy (250g)	CCOT12HV	-	-	-	130	150	175	200	230	250

10 stuks/verpakking - 10 pcs/emballage



G4™ NiTi Closed Coil Springs

	Force 21"	Spool
Ultra Light	100 gm	CCNT21075
Light	150 gm	CCNT21150
Medium	200 gm	CCNT21200
Heavy	250 gm	CCNT21250



G4™ NiTi Open Coil Springs

Wire size	I.D.	Force	Force when compressed 25% (.250") (Force in grams)	Force when compressed 50% (.500") (Force in grams)	7" Straight 21"	Spooled
.010"	.030	Light	120	260	OCNT10307	OCNT103021
.010"	.036	Med-Light	90	200	OCNT10367	OCNT103621
.012"	.030	Medium	220	480	OCNT12307	OCNT123021

3 stuks/verpakking - 3 pcs/emballage



G4™ NiTi Open Coil Springs

I.D.	Force		
.036	100gm	Light	OCNT15100
.036	150gm	Medium	OCNT15150
.036	200gm	Heavy	OCNT15200



10 stuks/verpakking - 10 pcs/emballage

Springs/Auxiliaires

G4 NiTi Open Coil Springs

	G4 Niti Molar Distalizing Open Coil Springs	
	7" Lengths	OCNT7045 (3pcs)
	21" Spool	OCNT2145

Stainless Steel Coil Springs

	STAINLESS STEEL Open Coil Springs (spool)	
	.010x.028	SSOC1028
	.010x.030	SSOC1030
	.010x.036	SSOC1036
	STAINLESS STEEL Closed Coil (spool)	
	.010x.030	SSCC1030

BONDABLE Lingual Attachments

BONDABLE Buttons		P/N
		Flat base 42-0020-0000
		Curved base 42-0010-0000
BONDABLE Cleats		P/N
		Flat base 42-0060-0000
		Curved base 42-0050-0000
		Eyelet 42-0070-0000
SURGICAL Buttons		P/N
	 1.3	Curved base 42-0030-0000
	 1.3	Flat base 42-0040-0000
10 stuks/verpakking - 10 pcs/emballage		
	V-SLOT OMNI HOOK	
	Description	P/N
	Hook for V-Slot (Bag of 50)	69-1410-0000

10 stuks/verpakking - 10 pcs/emballage

BONDABLE Lingual Attachments

COIL EYELETS

M006B-01 - 10 pcs



CERAMIC BUTTONS

FCB-00-01 - 10 pcs



CERAMIC HOOKS

FCB-00-01HK - 10 pcs



COMPOSITE BUTTONS

270-204 - 10 pcs



MIM DIRECT BOND EYELET

270-203 - 10 pcs



GOLD ERUPTION CHAIN

42-3150-0000

Gold Eruption Chain
round base - 5 pcs



42-3160-0000

Gold Eruption Chain
rectangular base - 5 pcs



TONGUE TRAINER

270-205

Tongue Trainer - 10 pcs



BITE BUMPER

BB-00-01

BITE BUMPERS - aesthetic- 10 pcs

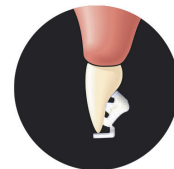

1. Put the placement-jig against the incisal edge

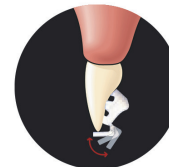

2. Remove the jig

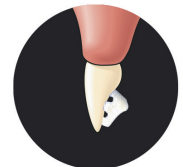

3. Bite-Bumper ready

MINI-MOLD SYSTEM

700-100M+ Starterkit

Kit includes: 24 Mini-Mold tips (3 of each style),
2 tip handles, detailed step-by-step instructions.



Bite Ramp

700-117 3mm
8 tips, 1 handle
700-117L 5mm
8 tips, 1 handle



Button

700-004
10 tips,
1 handle



Habit Control

700-116
10 tips,
1 handle



Molar Pad

700-007
10 tips,
1 handle

GOODMAN TORQUING SPRING™

- Torque veertje
- .013 roestvrij staal draad
- 125 tot 150 gram labiale of linguale root torque
- Crimpt op elke rechthoekige draad van .016x.022 tot .019x.025
- Verkrijgbaar in twee maten: Small & Large
- De small-versie is voor de laterale tanden upper/lower en de onderincisiven. De large voor al de andere tanden. (niet voor de molaren)
- Verpakt per 5 stuks



- Ressort de torsion
- fil d'acier inoxydable .013
- 125 à 150 grammes de torque labial ou lingual
- Sertissage pour tout fil rectangulaire de .016x.022 à .019x.025
- Disponible en deux tailles : Small & Large
- La version small est destinée aux dents latérales supérieures/inférieures et aux incisives inférieures. La version large pour toutes les autres dents (pas pour les molaires).
- Emballé par 5 pièces



GTS Complete kit 270-104

- 5 pcs small
- 5 pcs large
- 1 crimping plier

- 270-100**
5 pcs small
- 270-101**
5 pcs large



GTS Crimping plier
800-087

D2 APPLIANCE 271-600 one pair

- One size fits all om uw voorraad sterk te verminderen
- Laag profielontwerp voor meer comfort voor de patiënt
- Voor bilaterale of unilaterale behandeling
- Voor gemengd en permanent gebit
- Eenvoudig te gebruiken en gemakkelijk te plaatsen
- De totale behandelingstijd verkorten
- Gepatenteerd voor zowel klasse II als klasse III behandeling

- Une taille unique pour réduire considérablement votre inventaire
- Un profil bas pour le confort du patient
- Pour un traitement bilatéral ou unilatéral
- Pour les dents mixtes et permanentes
- Simple à utiliser et facile à placer
- Réduire la durée globale du traitement
- Breveté pour un traitement de classe II et de classe III

ONE SIZE
FITS ALL



D2 APPLIANCE CLEAR 271-600C





- Simple
- Precise
- Adaptable
- Efficient

Youtube introduction by
Dr. Yoav Mazor



MULTI-FA

Multi functional Appliance
for CL II and CL III Correction

Multi FA clinical uses:

1. CL II, CL III malocclusion correction
2. Open / regain spaces
3. Closing spaces

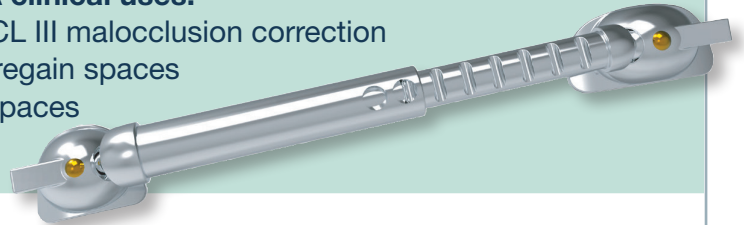

Double hinge for an
anatomical positioning
without compromise



Improvement of
the biomechanical control



Fix the hinge upon
treatment plan
requirements



**One appliance
for 90% cases!**

MULTI-FA for tubes, adaptable on patients

Can be used with open coil



mesio – distal stop made with a flow



or a crimpable stop

92-5001-0000
MULTI-FA Regular 18-28mm
(left & right) - 2 pcs

92-5002-0000
MULTI FA Short 12-17mm
(Left & Right) - 2 pcs

92-5003-0000
MULTI FA Long 23-36mm
(Left & Right) - 2 pcs

92-5004-0000
MULTI FA Band-R
(Left & Right) - 2 pcs

Clear X & intra-oral scanner



Shape-shifting aligner

1 aligner = 2

CLEAR X

THE EVOLUTION IN TEETH-ALIGNMENT



* Including MotionViewer Premium Plus Video Treatment Plan!

Unlimited modifications



TOUCH

0 3 6 12 12+

Under 3 months treatment for correction of a small number of malocclusions and minor relapses from previous orthodontic treatments.

Single and double arches
1 free refinement
Upper and lower retainers
Straight cut trimline
Template and laser mark
Remake upon request
Includes booster and app
1 aligner = 2 weeks



SMART

0 3 6 12 12+

Between 3 and up to 6 months treatment for correction of a small number of conditions and minor malocclusions.

Single and double arches
2 free refinements
Upper and lower retainers
Straight cut trimline
Template and laser mark
Remake upon request
Includes booster and app
1 aligner = 2 weeks



POWER

0 3 6 12 12+

Between 6 and up to 12 months treatment for mild cases with correction of a moderate number of conditions.

Single and double arches
3 free refinements
Upper and lower retainers
Straight cut trimline
Template and laser mark
Remake upon request
Includes booster and app
1 aligner = 2 weeks



INFINITY

0 3 6 12 12+

Over 12 months treatment for moderate to complex cases, with unlimited aligners for a period of 5 years or 180 days after ordering the end-of-treatment retainers.

Single and double arches
Unlimited refinements
Upper and lower retainers
Straight cut trimline
Template and laser mark
Remake upon request
Includes booster and app
1 aligner = 2 weeks



Portable Dental 3D Digital Intraoral Scanner Color Scanning 3D High Resolution



- Ergonomische afmetingen en gewicht. Scanner afmeting 240mm(L) x39.8mm(B)x 57mm(H).
- Gewicht 350g, afmeting scannertip 18.5mm(H)x19mm(W). Geschikt voor zowel kinderen als volwassen patiënten
- Poedervrij
- Chromoscan, Gekleurde scans die de ware tandheelkundige situatie in vivo en in real-time weergeeft
- Zeer nauwkeurig en snel scannen ongeveer ≤ 3 minuten
- Afneembare scannertip autoclaveerbaar tussen 121°C en 134°C
- Analyse van occlusierelaties
- Open en progressief systeem
- Gratis updates
- Geen jaarlijkse fee, enkel eenmalige aankoopprijs
- Compatibel met Clear X en andere aligner systemen

- Dimensions et poids ergonomiques, 240mm(L)x39.8mm(W) x57mm(H), Poids 350g, taille embout du scanner 18.5mm(H)x19mm(W)
- Convient aux enfants et aux adultes
- Sans poudre
- Chromoscan Scans colorés représentant la véritable situation dentaire en vivo et en temps réel
- Numérisation très précise et rapide environ ≤ 3 minutes.
- Embout amovible du scanner, autoclavable entre 121°C et 134°C
- Analyse des relations d'occlusion
- Système ouvert et progressif
- Mises à jour gratuites
- Pas de frais annuels, seulement un prix d'achat unique
- Compatible avec Clear X et d'autres systèmes d'alignement.

Toepassingen voor verschillende tandheelkundige behandelingen
Restauratieve tandheelkunde, Implantologie en Orthodontie

Applications pour différents traitements dentaires
Dentisterie restauratrice, Implantologie et Orthodontie



Portable digitalized orthodontics treatment workflow



1.
Intraoral data acquisition



2.
Design



3.
3D model printing



4.
Compression molding of aligners

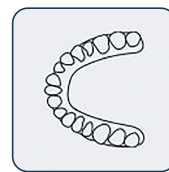

5.
Completion



6.
Try-on





Aligner Supplies & Burs / Produits pour Aligneurs & Fraises



STRIPPING

DENTASONIC DSPK-2



- with more items**
 + 8 Strip
 + 2 Debonding polishers
 + Stery Strip Holder
 + 2 CombiStrip
 + 1 BioMin Remineralization toothpaste

Silent hand piece, no vibration.
Internal water cooling and interchangeable head

DENTASONIC CORDLESS IPR-EVO MOTOR

IPR-EVO1



REFILL DENTASONIC STRIPS

	DIASTRIP		Double Sided		Single Sided		
	DiaStrip 5 pcs	0.10 mm, 15 micron	DSM-01-5	DSM-01R-5	Right	DSM-01L-5	Left
	DiaStrip 5 pcs	0.20 mm, 25 micron	DSM-02-5	DSM-02R-5	Right	DSM-02L-5	Left
	DiaStrip 5 pcs	0.30 mm, 40 micron	DSM-03-5	DSM-03R-5	Right	DSM-03L-5	Left
	DiaStrip 5 pcs	0.40 mm, 60 micron	DSM-04-5	-	Right	-	Left
	DiaStrip 5 pcs	0.50 mm, 60 micron reduction	DSM-05-5	-	Right	-	Left
	Diamant on resin	0.40 mm, 60 micron reduction	RDS-04-5	-	Right	-	Left

	DIASTRIP SAW & DIAMOND		Double Sided
	DiaSaw 5 pcs	0.10 mm, 15 micron	DSS-01-5
	DiaSaw 5 pcs	0.20 mm, 25 micron	DSS-02-5

	POLISTRIP		Double Sided
	PoliStrip 12 pcs	0.10mm (ultra fine)	RPS-9
	PoliStrip 12 pcs	0.15mm (fine)	RPS-15

ALIGNER DIASTRIP SET

DSA-S5 - 5pcs

- 1x 0.1 mm - 1x 0.15 mm
- 1x 0.2 mm - 2x PoliStrip



DENTASONIC STERYSTRIP

ST-6 Stainless Steel Strip Holder for 6 strips or burs (empty)

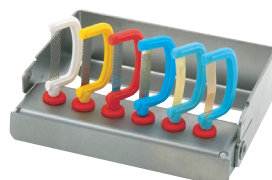

DENTASONIC SS MEASURING GAUGE

MG-6 6 thicknesses (0.1mm, 0.15mm, 0.2mm, 0.3mm, 0.4mm, 0.5mm)













STRIPPING

AIRO STRIPS

An innovative interproximal reduction system that makes interproximal enamel removal safer and more accurate without creating sharp corners or subgingival ledges. Designed for use with all orthodontic treatments, these strips curve and flex along the natural contours of the teeth to avoid cutting lips and gums, to prevent excessive enamel removal, and to maximise patient comfort.

- Stainless steel strips with high quality diamond powder
- Medical grade plastic casing
- Single-handed, ergonomic design reduces hand fatigue
- Effective for anterior teeth and easy access to posterior areas
- User and patient friendly
- Autoclavable up to 140°C (steam heat only)



	Yellow IPR 0.06mm Single-Sided, Extra-Fine Diamond Serrated. Sold in pack of 8.	DB05-0900
	Red IPR 0.12mm Double-Sided Medium Diamond. Sold in pack of 8.	DB05-0901
	Dark Blue IPR 0.15mm Double-Sided Coarse Diamond. Sold in pack of 8.	DB05-0902
	Green IPR 0.20mm Double-Sided Coarse Diamond. Sold in pack of 8.	DB05-0903
	Clear IPR 0.10mm Single-Sided Medium-Fine Diamond, Serrated. Sold in pack of 8.	DB05-0904
	Cyan IPR 0.12mm Single-Sided Medium-Coarse. Diamond. Sold in pack of 8.	DB05-0905
	Purple IPR 0.25mm Double-Sided Coarse Diamond. Sold in pack of 8.	DB05-0906
	Brown IPR 0.30mm Double-Sided Coarse Diamond. Sold in pack of 8.	DB05-0907
	Intro pack (1 of each colour). Sold in pack of 8.	DB05-0908
	Incremental Thickness Gauge (Set of 6) Stainless Steel - 0.1, 0.2, 0.25, 0.3, 0.4, 0.5mm. Sold individually.	DB05-0915

STRIPPING

INTERPROXIMAL DIAMOND BUR

8392.314.016
Diamond Bur FG
Pack of 5 pcs



DIAMOND BUR

852.204.037
Contre-Angle/Hoekstuk
Pack of 5 pcs



8833.314.031 Diamond bur FG
8833/031 - Pack of 5 pcs
Friction grip

KOMET BUR



Diamond bur RA
Pack of 5 pcs
801.204.023
801.204.029
801.204.035

STRIPPING DISC CFR. ZACHRISSON

8934A.900.100 10mm diamond disc
8934A.900.140 14mm diamond disc
8934A.900.180 18mm diamond disc
8934A.900.220 22mm diamond disc

Pack of 1 pc



**Mandrel for Zachrisson
disc**
303.204.050

Pack of 6 pcs

DIAMOND STRIPPING DISC DOUBLE-SIDED

911H.204.140 Medium Grain Double Sided - 14 mm diam
911H.204.180 Medium Grain Double Sided - 18 mm diam

Pack of 1 pc

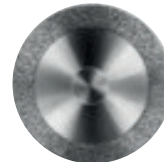

HORICO STRIPS

DB05-0324B Enamel Stripper Blade 4mm Double Sided
DB05-0324S Enamel Stripper Blade 4mm Single Sided
DB05-0328D Enamel Stripper Blade 6mm Double Sided
DB05-0328S Enamel Stripper Blade 6mm Single Sided

Pack of 12 pcs

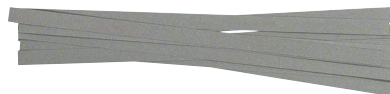

DIAMOND STRIP SINGLE SIDED

WS25 Medium 45µm (blue)
WS25F Fine 30µm (red)
WS25EF Extra-Fine 15µm (yellow)
WS25A Starterkit 5 strips/type



ALIGNER SUPPLIES

GC EXAFLEX PUTTY & EXAMIX NDS



GC IMPRESSION SEPARATION WAFER



AFDRUK in 1 fase

- Bring de Exaflex putty in de geperforeerde afdruklepel
- Maak een gleuf en injecteer de Examix NDS

AFDRUK in 2 fase

- Bring de Exaflex putty in de geperforeerde afdruklepel
- Plaats een Separation wafer op de putty en neem de afdruk
- Verwijder de Separation wafer na de afdruk genomen te hebben
- Injecteer de Examix NDS en neem opnieuw een afdruk

Pakket

- Putty1-1pak (500g lichtblauwe basis + 500g gele katalysator), **138801**
- Examix NDS Injection, pak van 2 cartridges + mengnaalden, **1000502**
- Cartridgedispenser, **800006**
- Separation Wafers 30 pcs, **800099**

EMPREINTE en une phase

- Mettez l'Exaflex Putty dans un porte-empreinte perforé
- Créez une fente et injectez l'Examix NDS

EMPREINTE en deux phases

- Insérer le mastic Exaflex dans le porte-empreinte perforé
- Placez une feuille d'espace sur le mastic et prenez l'empreinte.
- Retirer la feuille d'espaceur après l'empreinte
- Injecter l'Examix NDS et reprendre une empreinte.

Paquet

- Putty1-1 (base bleue 500 g & catalyseurjaune500 g), **138801**
- Examix NDS Injection, coffret de 2 cartouches + embouts mélangeurs, **1000502**
- Cartridge Dispenser (distributeur de cartouche), **800006**
- Separation Wafers 30 pcs, **800099**

ALIGNER SUPPLIES

ORTHO EASE CHEWIES

DB04-4231

Aligner Chewies
plain unscented (2 x 10 pcs)

DB04-4230

Aligner Chewies
Mint (2 x 10 pcs)



ORTHO EASE RETRIEVERS

DB04-4220 - 10 pcs



ALIGNER REMOVERS

700-640 - 12 pcs



TOMAS® ALIGNER HOOK

UL/LR: **302-021-00**

UR/LL: **302-021-10**

Each pack contains 10 pcs



POWER ARMS

Right **L4783**

Left **L4784**

Each pack contains 10 pcs



IXION ALIGNER PLIER



Aligner Kit **IX886**

this kit contains

- IX887 Torque plier
- IX888 Rotation plier
- IX889 Retention plier
- IX891 Hole Punch plier
- IX890 Tear Drop plier

Meer informatie over de Aligner instrumenten in het hoofdstuk instrumenten.

Plus d'informations dans le chapitre des instruments.

ALIGNER SUPPLIES

GC ALIGNER CONNECT™

Specifically formulated for aligner attachments

Als eerste in de industrie is GC Aligner Connect speciaal ontwikkeld voor orthodontische aligner attachments. GC Aligner Connect biedt een verbeterde esthetiek, imiteert de glazuur kleurschakeringen van de tand en heeft een hoge duurzaamheid, die slijtage op lange termijn of mogelijke loslating beperkt tijdens de behandeling. Kan gebruikt worden in combinatie met de G-premio Bond, Ortho Solo of Assure.

90-4100-0000 GC Aligner connect - 1 syringe 3,4g with 20 tips

Composite développé pour les traitements par gouttières

La résine composite généralement utilisée pour créer des taquets ne répond pas aux impératifs des traitements par gouttières d'alignement. Aucune résine existante sur le marché n'a spécialement été créée pour cette application. GC Aligner Connect a été développé dans ce sens, afin d'apporter une réponse esthétique par mimétisme de la teinte de la dent et limiter l'usure et les risques de décollement grâce à sa grande résistance. L'adhésion à l'émail se fera par l'intermédiaire d'un agent de collage photopolymérisable (ex: G-premio Bond, Ortho Solo, Assure, etc...). Suivre les instructions de l'agent de collage.

90-4100-0000 GC Aligner connect - 1 syringe 3,4g with 20 tips



PERFECT-A-SMILE

Perfect-a-Smile, een pontic verf voor aligners

Is een licht uithardende pasta in 3 tinten die op elk type aligner kan worden aangebracht om een ruimte of een ontbrekende tand te maskeren.

Perfect-a-Smile, une peinture pontique pour les gouttières.

Une pâte photopolymérisable en 3 teintes qui peut être appliquée sur tout type de gouttière pour masquer un espace ou une dent manquante.



600-418
Shade A2 - 4gm
600-418D
Shade A3.5 - 4gm
600-419
Shade B1 - 4gm

CERAMIC BUTTONS

FCB-00-01- 10 pcs



CERAMIC HOOKS

FCB-00-01HK- 10 pcs



COMPOSITE BUTTONS

270-204- 10 pcs



MINI-MOLD SYSTEM

700-100M+ Starterkit

Kit includes: 24 Mini-Mold tips (3 of each style),
2 tip handles, detailed step-by-step instructions.



Bite Ramp
700-117 3mm
8 tips, 1 handle
700-117L 5mm
8 tips, 1 handle



Button
700-004
10 tips,
1 handle



Habit Control
700-116
10 tips,
1 handle



Molar Pad
700-007
10 tips,
1 handle

DEBONDING BURS

TUNGSTEN CARBIDE BURS

Flame shaped - for removing bonding
Pack of 5 pcs



	
Friction Grip/Turbine	Contre-Angle/Hoekstuk
H282K-314-014	H282K-204-014

TUNGSTEN CARBIDE BURS

Ball shape - for removing bonding
Pack of 5 pcs



	
Friction Grip/Turbine	Contre-Angle/Hoekstuk
H379-314-018 H379-314-023	H379-204-018 H379-204-023

DIAMOND BURS

Friction Grip/Turbine **909.314.040**
Contre-angle/Hoekstuk **909.204.040**
Pack of 5 pcs



MEISINGER POLISHER FLAME

Ceramic Abrasive
Contre-Angle/Hoekstuk **655.204.288**
Pack of 5 pcs



DEBONDING POLISHER

Contre-Angle/Hoekstuk
DB-R20 Dentasonic Refill Cup - 6 pcs
DB-R21 Dentasonic Refill Point - 6 pcs



STAINBUSTER

STANDARD: LENGTH 25 MM

JUMBO: LARGE HEAD

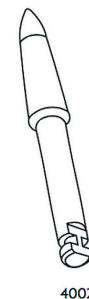
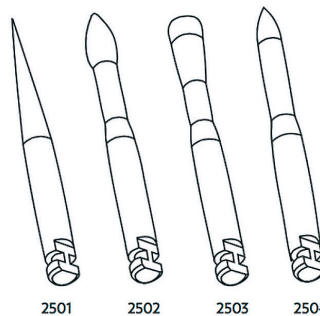

10003763 Stainbusters Standard RA-2502
10004211 Stainbusters Standard RA-2501
10004747 Stainbusters Standard RA-2503
10004748 Stainbusters Standard RA-2504
Pack of 6 pcs

10000646
Stainbuster Jumbo RA-4002

ALIGNER PLIERS

IX887

The Torque Aligner Plier

The IX887 creates a horizontal indentation (0.75 x 1.5mm), creating a force point for individual lingual or labial root torque.

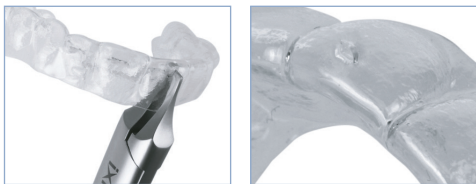

IX892

Ixion Aligner Scissors

These lightweight scissors are used for removing excess thermoformed material, and for the smooth trimming and shaping of aligners. Their streamline design, graduated curve and tapered beak makes for easy use - even in tight areas.



IX889

The Retention Aligner Plier

to create a circular indentation (1mm).

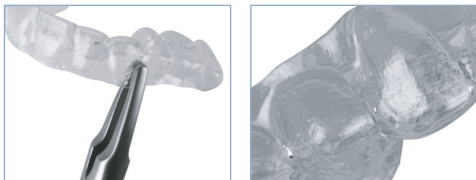

IX888

The Rotation Aligner Plier

The IX888 creates a vertical indentation / force point (0.75 x 1.5mm) on the tooth surface to optimise tooth rotation.

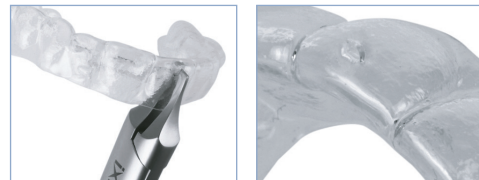

IX891

The Hole Punch Plier

Creates a half-circle cut-out in the aligner to give clearance for bonded buttons, tubes or brackets with hooks for elastics.

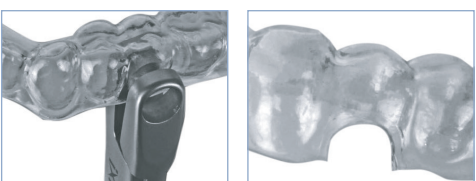

IX890

The Tear Drop Plier

Create a cut at the gingival margin, anywhere along the arch - buccally, labially or lingually - to conveniently hold elastics in place while the aligner is placed in the mouth.

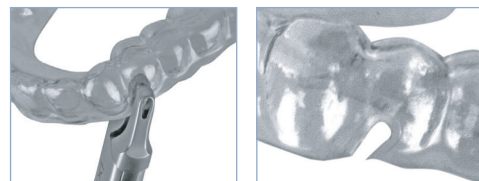



Extra-Oral Traction/ Traction Extra-Oral

FACEBOWS

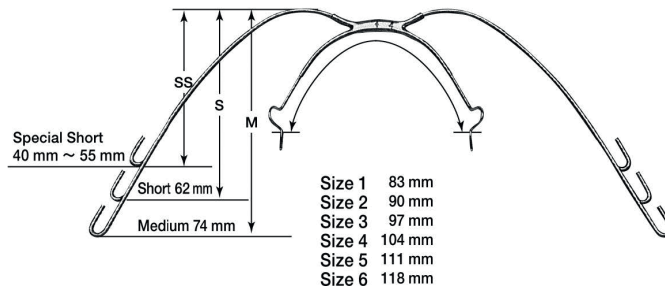

Outer bow	Special Short	Sp. Short 0.51	Short	Short 0.51	Medium
Universal	62-11UN-0000	—	62-21UN-0000	—	62-31UN-0000
Size 1	62-1110-0000	—	62-2110-0000	—	—
Size 2	62-1120-0000	62-1320-0000	62-2120-0000	62-2320-0000	—
Size 3	62-1130-0000	62-1330-0000	62-2130-0000	62-2330-0000	62-3130-0000
Size 3.5	—	—	62-2135-0000	—	—
Size 4	62-1140-0000	62-1340-0000	62-2140-0000	62-2340-0000	62-3140-0000
Size 4.5	—	—	62-2145-0000	—	—
Size 5	62-1150-0000	—	62-2150-0000	62-2350-0000	62-3150-0000
Size 6	—	—	62-2160-0000	—	62-3160-0000

Verpakt per stuk/ Emballé par pièce

LIP BUMPER

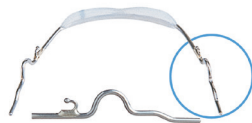

Lip Bumper Natural® 1

Description	P/N
Lip Bumper Natural® 1 size 0	63-1100-0000
Lip Bumper Natural® 1 size 1	63-1101-0000
Lip Bumper Natural® 1 size 2	63-1102-0000
Lip Bumper Natural® 1 size 3	63-1103-0000
Lip Bumper Natural® 1 size 4	63-1104-0000
Lip Bumper Natural® 1 size 5	63-1105-0000
Lip Bumper Natural® 1 size 6	63-1106-0000

Verpakt per stuk/Emballé par pièce



Lip Bumper Natural® 2

Description	P/N
Lip Bumper Natural® 2 Universal	63-31UN-0000
Lip Bumper Natural® 2 size 0	63-3100-0000
Lip Bumper Natural® 2 size 1	63-3101-0000
Lip Bumper Natural® 2 size 2	63-3102-0000
Lip Bumper Natural® 2 size 3	63-3103-0000
Lip Bumper Natural® 2 size 4	63-3104-0000

Verpakt per stuk/Emballé par pièce

PALATAL BARS

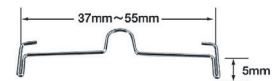

Mesial Loop Palatal Bars

Size	P/N	Size	P/N
35	64-0M11-0035	47	64-0M11-0047
37	64-0M11-0037	49	64-0M11-0049
39	64-0M11-0039	51	64-0M11-0051
41	64-0M11-0041	53	64-0M11-0053
43	64-0M11-0043	55	64-0M11-0055
45	64-0M11-0045	—	—

Verpakt per 5 stuks/Emballé par 5 pcs

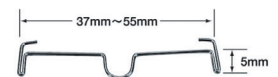

Distal Loop Palatal Bars

Size	P/N	Size	P/N
35	64-0D11-0035	47	64-0D11-0047
37	64-0D11-0037	49	64-0D11-0049
39	64-0D11-0039	51	64-0D11-0051
41	64-0D11-0041	53	64-0D11-0053
43	64-0D11-0043	55	64-0D11-0055
45	64-0D11-0045	—	—

Verpakt per 5 stuks/Emballé par 5 pcs

NECKPADS & HEADCAPS

NECKPADS NAVY BLUE

NSPS/DB

Neckpads double looped
medium filled
Navy Blue - 1pce



CPDB10

Denim Blue Neckpad - 5 pcs

HEADCAPS NAVY BLUE

03-0197 Head Cap Navy Blue
Small - 1 pc

03-0198 Head Cap Navy Blue
Medium - 1 pc

03-0199 Head Cap Navy Blue
Large - 1 pc



SILKY BRUSHED MICROFIBER COVERED NECK PAD

- Silky brushed micro fiber 7" (178mm)
- 10 per bag
- Available in Navy Blue

O-8S 7" Neck Pad - Navy



CERVICAL TRACTION BANDS

- 10 per bag
- Available in Navy Blue

O-9A Cervical traction bands.
Medium hard, one stripe
elastic bands

O-9E Cervical traction bands.
Extra hard, three stripe
elastic bands.



DELAIRE MASK

03-0257

Face Mask Delaire small - beige

03-0261

Face Mask Delaire large - beige



MULTI-ADJUSTABLE PROTRACTION MASK

550-100
Blue (1/pk)

550-101
Red (1/pk)

550-102
Pearl (1/pk)

550-103
Clear (1/pk)



SAFETY RELEASE MODULES

600 gr

Dark Blue

03-0230



Pack of 10 pcs

HEADGEAR STORAGE CASES

HGSTBK Black

HGSTRD Red

HGSTRB Royal Blue

HGSTGR Green

HGSTPP Purple



Pack of 5 pcs





Instrumenten/ Instruments

ALIGNER PLIERS

IX887

The Torque Aligner Plier

The IX887 creates a horizontal indentation (0.75 x 1.5mm), creating a force point for individual lingual or labial root torque.



IX892

Ixion Aligner Scissors

These lightweight scissors are used for removing excess thermoformed material, and for the smooth trimming and shaping of aligners. Their streamline design, graduated curve and tapered beak makes for easy use - even in tight areas.



IX889

The Retention Aligner Plier

to create a circular indentation (1mm).



IX888

The Rotation Aligner Plier

The IX888 creates a vertical indentation / force point (0.75 x 1.5mm) on the tooth surface to optimise tooth rotation.

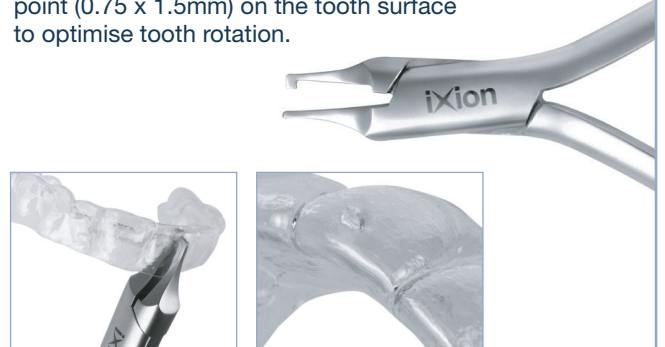

IX891

The Hole Punch Plier

Creates a half-circle cut-out in the aligner to give clearance for bonded buttons, tubes or brackets with hooks for elastics.

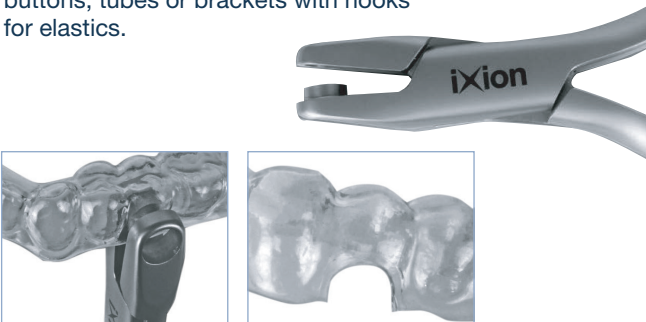

IX890

The Tear Drop Plier

Create a cut at the gingival margin, anywhere along the arch - buccally, labially or lingually - to conveniently hold elastics in place while the aligner is placed in the mouth.



LINGUAL SERIES

ixionTM
Instruments

IX949

Slim Tweed Plier

This instrument has slimmer tips - just 0.9mm



IX950

Weingart 60° Angle

Maximum .018" (.46mm) wire.



IX952

Stepped Tweed Arch Plier

Designed for torquing and bending both square and rectangular wires.



IX953

Cinch Back

The serrated tips of this instrument hold the wire securely while bending the wire 90° distal to the buccal tube.

For use with Nickel Titanium wires
.012" - .018" (.30 x .46mm).



IX954

Cinch Back - Large Wire

Same features as ix953 but designed to work with larger wires.

For use with wires from .016" (.41mm)
up to .021" x .025" (.55 x .64mm).



IX955

Bracket Removing Plier



IX956

Mini Ligature Cutter 50° Angle Upper

Maximum Cutting Capacity, soft wire up to .012" (.30mm)



IX956s

Micro Ligature Cutter Upper 50° Angle Upper

Maximum Cutting Capacity, soft wire up to .012" (.30mm)



LINGUAL SERIES



IX911

Micro Ligature Cutter
Maximum Cutting Capacity: soft wire up to .012" (.30mm)

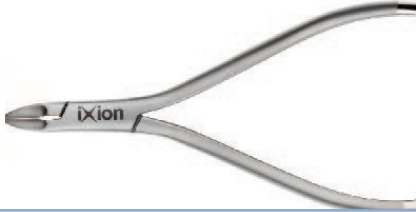

IX911L

Micro Long Handled Ligature Cutter
Maximum Cutting Capacity: soft wire up to .012" (.30mm)



IX958 / IX958S

Flush Cut Distal End Cutter
Standard / Small

Minimum Cutting Capacity:
ix958 - .016" - ix958s .012"
Maximum Cutting Capacity:
ix958 archwires up to .021" x .025"
ix958s archwires up to .016" x .025"



IX959

Long Handled Distal End Cutter
With T.C. inserts.

Minimum Cutting Capacity: .012"
Maximum Cutting Capacity:
.018"x.025"



IX632

Lingual Bracket and Bondable Tube Holder



IX941

Curved Lingual Micro Mosquito



IX940

Curved Smaha

excellent for placing elastomerics to brackets



CUTTERS



IX900

Distal End Cutter

Cutting Capacity: archwires up to .021" x .025"



IX900s

Distal End Cutter

Allows you to routinely cut beta titanium, braided and co-axial wires with ease. Cutting Capacity: archwires up to .016" x .022"



IX901

Long Handled Distal End Cutter

Cutting Capacity: archwires up to .021" x .025"



IX905

Hard Wire Cutter

Minimum Cutting Capacity: .012"
Maximum Cutting Capacity: archwires up to .021" x .025"



IX902 / IX902s

Flush Cut Distal End Cutter Standard / Small

IX902

Minimum Cutting Capacity: .016"
Maximum Cutting Capacity: archwires up to .021" x .025"

IX902s

Minimum Cutting Capacity: .012"
Maximum Cutting Capacity: archwires up to .016" x .025"



Using none flush cut distal end



Using flush cut distal end



CUTTERS

IX915

Hard Wire Cutter with T.C. Inserts
Minimum Cutting Capacity: .012"
Maximum Cutting Capacity: archwires up to .021"x .025"



IX906

Hard Wire Cutter 15° Angle
Minimum Cutting Capacity: .012"
Maximum Cutting Capacity: archwires up to .021"x .025"

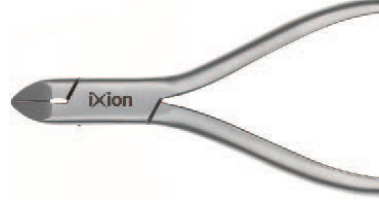

IX916

Hard Wire Cutter 15° Angle with T.C. Inserts
Minimum Cutting Capacity: .012"
Maximum Cutting Capacity: archwires up to .021"x .025"

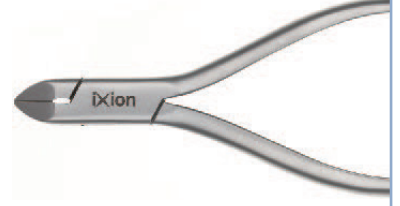

IX908

Heavy Duty Hard Wire Cutter
Minimum Cutting Capacity: .014" (.36mm)
Maximum Cutting Capacity: wire up to .060" (1.5mm)



IX910

Pin Ligature Cutter 7° Angle
Maximum Cutting Capacity: soft wire up to .016"

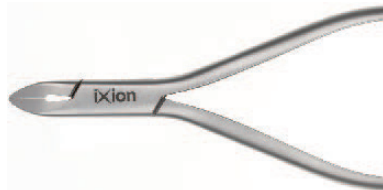

IX911

Micro Ligature Cutter
The inserted tips ensure precision cutting of ligature wire and elastics. Maximum Cutting Capacity: soft wire up to .012"

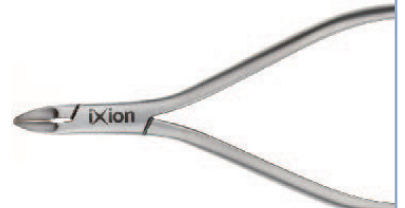

IX911L

Micro Long Handled Ligature Cutter
Maximum Cutting Capacity: soft wire up to .012"



IX912

Standard Ligature Cutter
Maximum Cutting Capacity: soft wire up to .015"

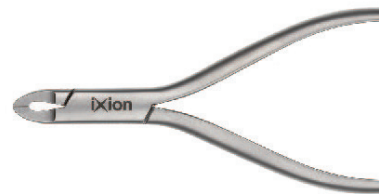

IX913

Standard Soft Wire Ligature Cutter
Maximum Cutting Capacity: soft wire up to .012"



UTILITY PLIERS

IX800

Small Weingart

Holds round, square and rectangular wires up to .022" x .028



IX801

Small Weingart with T.C.

Inserted T.C. tips providing maximum wire control. Holds round, square and rectangular wires up to .022" x .028"

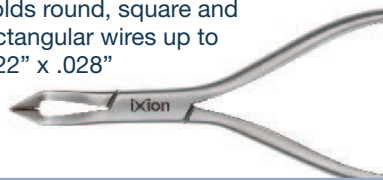

IX802

Large Weingart

Holds wire up to .030"



IX803

Large Weingart with T.C.

Holds wire up to .030"



IX804

Fine Tipped Weingart

Holds wire up to .022" x .028"



IX843

Utility Weingart with Inserted Tips

Holds wire up to .022" x .028"



IX805

How Plier (Straight)

Holds wire up to .022" x .028"



IX806

How Plier (Angled)

Holds wire up to .022" x .028"



IX820

Crimpable Archwire Hook Plier



IX834

Crimping Plier

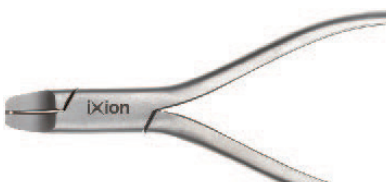

IX825

Posterior Band Remover (Short)

Replacement Tips 3/16" (5mm) - IX895S

Replacement Tips 1/8" (4mm) - IX896S



UTILITY PLIERS

IX826

Posterior Band Remover (Long)
Replacement Tips 3/16" (5mm) - IX895S
Replacement Tips 1/8" (4mm) - IX896S



IX838

Posterior Band Remover Plier
Replacement Tips. Pack of 10.



IX827

Direct Bond Remover (Straight)



IX828

Direct Bond Remover (Angled 60°)



IX829

Direct Bond Remover



IX840

Small Adams Plier
Effective for wires up to .030"

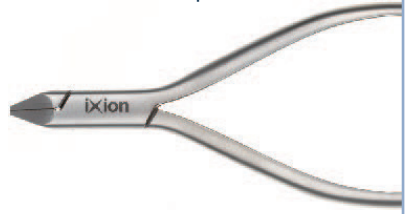

IX841

Force Module Separator



IX895S

Replacement Tips 3/16" (5mm)
for IX825/826, Pk 3



IX896S

Replacement Tips 1/8" (4mm)
for IX825/826, Pk 3



IX838S

Posterior band remover tips
for IX838 Posterior Band Remover



WIRE BENDING PLIERS

IX807

Light Wire Plier

Tips bend archwires from .012" to .020".

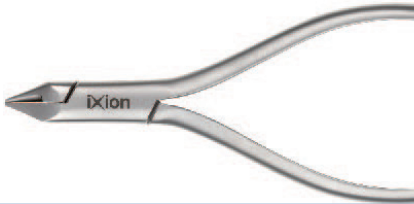

IX809

Light Wire Plier with Cutter

Tips bend archwires from .012" to .020".
Cutter at the base of beaks cuts archwires from .014" to .020".

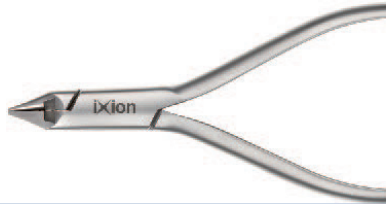

IX810

Bird Beak Plier

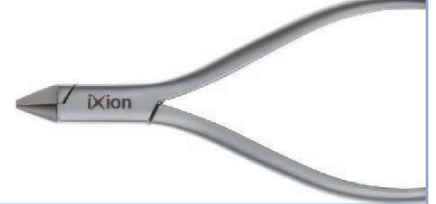

IX812

Tweed Loop Forming Plier with Cutter

The tip has three sections of 1.2mm, 1.8mm and 2.0mm.
For use with round and square wire up to .021 x .025".
The built in cutter allows wire to be cut from .014" to .020".

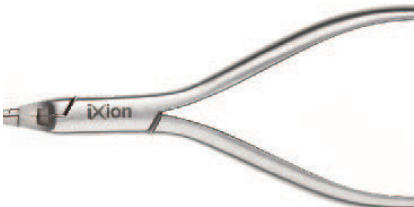

IX813

Tweed Arch Forming Plier

For use with wires up to .021" x .025".



IX821

Long Beak Light Wire Plier

For use with round and square wire up to .020" (.51mm).



WIRE BENDING PLIERS

IX872

Bird Beak Plier with T.C.

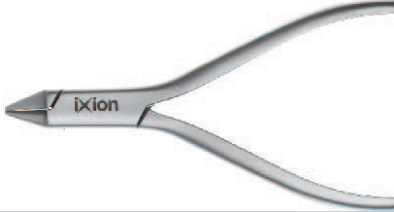

IX873

Torquing Plier Set



IX819

Small 3-Jaw Plier
For working with wire up to .020".



IX814

O'Brien Loop Forming Plier
The perfect plier for making Accurate, Omega and Closing loops. Can be used with round & square wire up to .021" x .025" (.55 x .64mm).



IX815

Nance Plier
Precision loop forming with four step tips 3mm, 4mm, 5mm and 6mm. Excellent for round and square wires up to .022".



IX816

3-Jaw Plier
For use with wire up to .030".



IX817

De La Rosa
For use with wires up to .021" x .025".

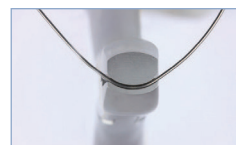

WIRE BENDING PLIERS



IX830

Hollow Chop



IX975

Intra Oral Detailing Plier 0.75mm Step

For use up to max .018" x.018" wire.



IX823

Fine 3-Jaw Plier

Can be used on Nickel Titanium and
Stainless Steel wire up to 0.20".



IX976

Intra Oral Detailing Plier 0.5mm Step

For use up to max
.018" x.018" wire.



HAND INSTRUMENTS & HEMOSTATS



IX650
Probe Single Ended



IX651
Probe Double Ended



IX652
Ligature Tucker



IX653
Mitchell Trimmer



IX656
Cement Spatula



IX657
Flat Plastic



IX654
Mirror Handle



IX655
Mirror Heads Pk 12

HAND INSTRUMENTS & HEMOSTATS

IX850

Direct Bond Bracket Holder



IX630

Direct Bond Holder with Positioning Blade



IX631

Deluxe Direct Bond Holder



IX632

Lingual Bracket and Bondable Tube Placer



IX633

Curved Bracket Holder



IX845

Mershon Band Pusher



IX861

Mathieu Needle Holder with T.C.
Designed for twisting
ligature wire.



IX862

Mathieu Needle Holder
Designed for twisting
ligature wire.



IX863

Smaha (Straight)
Fine tips excellent for placing
elastomeric ligatures.



HAND INSTRUMENTS & HEMOSTATS

IX855

Mosquito Forceps

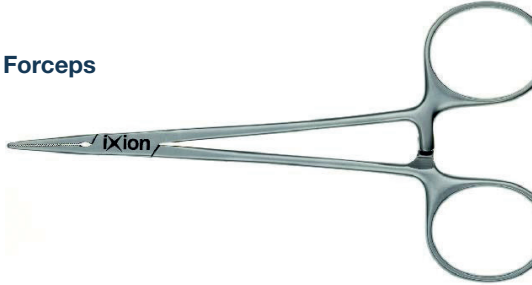

IX860

Fine Tip Mathieu Needle Holder



IX940

Curved Smaha

Excellent for placing elastomerics to lingual brackets.



IX941

Curved Lingual Micro Mosquito

Used to place elastic ligatures.

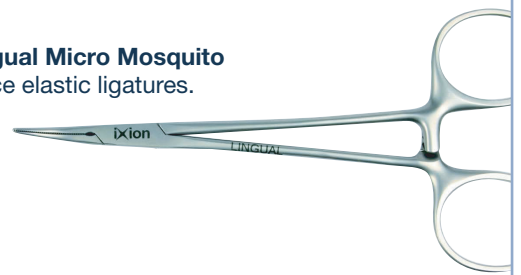

IX866

Bracket Height Gauge

3.5mm-5mm .018

For precise bracket positioning of .018 brackets.



IX867

Bracket Height Gauge

3.5mm-5mm .022

For precise bracket positioning of .022 brackets.



HAND INSTRUMENTS & HEMOSTATS

IX892

Ixion Aligner Scissors



IX101

Small Rack
Autoclavable
Stainless Steel Rack
size L 110mm x H 120mm



IX103

Large Rack Autoclavable Stainless Steel Rack
size L 310mm x H 125mm



IX102

Medium Rack
Autoclavable
Stainless Steel Rack
size L 155mm x H 120mm



DB04-000/1

Clear Upright Instrument Rack
Keep your instruments organised
will hold up to 15 instruments



LABORATORY PLIERS

IX164

Adams Plier

Bends hard wire up to .039" (1.00mm) max.



IX165

Spring Former Plier

With tungsten Carbide inserted tips.
Bends hard wire up to 0.28" (0.7mm) max.



IX700

Universal General Use Plier

Both Tips are serrated. Bends hardwire up to .039" (1.0mm) max. Cuts hardwire up to .028" (0.7mm) max.



IX702

Three Jaw Plier

For hard wire up to .024" (1mm) max.



IX703

Young Plier

For labial arches and canine loops.
For hard wire up to .028" (0.7mm) max.



IX705

Lingual Arch Bending Plier

Grooved to hold all larger wire sizes, jaw width is .120" (3.05mm). Also ideal for double and triple back bends. Bends round, square and rectangular wires up to .036" (0.91mm) max.

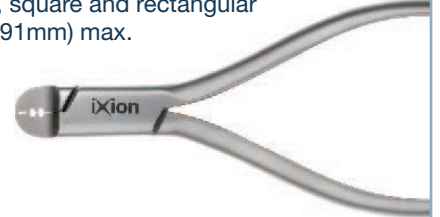

IX708

Optical Plier

For hardwire up to .028" (0.7mm) max.



IX711

Heavy Duty Bird Beak

Bending of wire up to .040" 1mm.



INSTRUMENTS

BRACKET DELUXE HOLDER

DB05-0421



STANDARD BRACKET HOLDER

DB05-0420



BONDABLE TUBE HOLDER

DB05-0423



CEMENT SPATULA

Multifunctional orthodontic hand instrument with precision manufactured tip.

DB05-0325



COLLEGE TWEEZERS

DB05-0319



PEDO CURVED SCISSORS

DB05-0331



OVERBITE RULER

Aluminium ruler for easy measuring of overbite.

DB05-0001



ARCH FORMER - Tweed Style

Will bend wires up to .022" x .028".

DB05-0712



DOUBLE ENDED PROBE

DB05-0312



INSTRUMENTS

SPECTRUM STEP PLIER

800-276 (1mm)
800-277 (3/4mm)
800-278 (1/2mm)



SWIVEL HEAD BRACKET Height Gauge

800-068

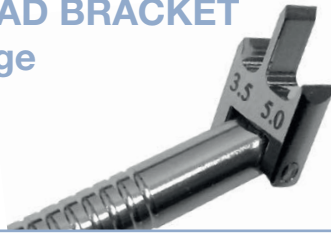

SPECTRUM TORQUING PLIER SET w/Wide Key

800-130
800-131
replacement key

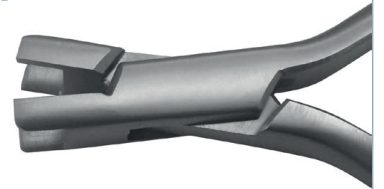

LARGE MOUTH MIRROR

800-050 38,10mm



BOONE BRACKET Gauge

800-034



DOUBLE ENDED ELASTIC REMOVER

800-069



BAND SEATER/BITE STICK

autoclavable and cold sterilization

800-0182



REVERSE ACTION KEAT MOLAR TUBE PLACER

800-039L

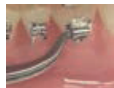

CINCH BACK / DISTAL BENDER

800-075



BRACKET POSITIONER

800-046



5-IN-1 BRACKET PLACER & ALIGNER

800-041



INSTRUMENTS

SHORTY TWIST HOLDER

800-133



LITE DOUBLE ENDED LIGATURE DIRECTOR

800-062 (1/4")
800-062W (3/8")



LITE BAND PUSHER / SCALER

(3/8") 800-064W



LITE LIGATURE REMOVER / DIRECTOR

(1/4") 800-065 / (3/8") 800-065W



MATHIEU NEEDLE HOLDER w/Safety Latch-Regular Tip

A wider serrated tip to hold ligature wire and Kobyashi Hooks firmly during placement.

800-122



MATHIEU NEEDLE HOLDER w/Safety Latch-Fine Tip

A finer serrated tip to securely place elastic ligature and wires.

800-120



MATHIEU NEEDLE HOLDER w/Safety Latch-Ultra Fine Tip

This ultra-fine tip is designed specifically to place elastic ligatures securely and more easily by taking up less of the donut.

800-121



INSTRUMENTS

BRACKETIZER Blue Handle

800-076



50-2030-0000

For Experience metal/rhodium



50-0032-0000

For Experience Mini metal/rhodium



DB05-0311

Double ended tucker



LM411-415ES

LM Ligature Director

50-0030-0000

For Experience metal/ceramic
and rhodium



HORIZONTAL PLIER RACK w/ Cover (12 Pliers)

700-074



UPRIGHT PLIER RACK w/Cover (12 pliers)

700-071



OIL PEN van Carl Martin

990



PLIER CAROUSEL w/ Center Tube

700-075



SILICONE COLOR CODED INSTRUMENT RINGS

(80)

700-050







Myofunctional/ Myofunctionelle

The Trainer System™

The original appliance range for myofunctional orthodontics!

INFANT TRAINER

PRIMAIR GEBIT 2-5 jaar

De Infant Trainer™ is een actief oefentoe-stel dat het kind aanmoedigt om correct te kauwen terwijl het de kaakspieren gebruikt. Het belangrijkste is dat de Infant Trainer™ het kind aanmoedigt om door de neus te ademen terwijl het tegelijkertijd traint om te slikken en de tong correct te positioneren.

DENTITION LACTÉALE 2-5 ans

L'Infant Trainer™ est un appareil d'exercices actifs qui encourage l'enfant à mâcher correctement tout en utilisant les muscles de la mâchoire. Plus important encore, l'Infant Trainer™ encourage l'enfant à respirer par le nez tout en l'entraînant à avaler et à positionner correctement sa langue.



One size

590010 Soft Silc. Blue **590020** Hard Blue
590015 Soft Silc. Rose **590025** Hard Rose

TRAINER FOR KIDS - T4K®

GEMENGD GEBIT 5-8 jaar

De T4K® serie is het meest effectief in de vroege gemengde dentitie voor begeleiding van de tanderuptie en correctie van myofunctionele gewoonten.

DENTITION MIXTE 5-8 ans

La série T4K® est la plus efficace en dentition mixte précoce pour le guidage de l'extraction dentaire et la correction des habitudes myofonctionnelles.



T4K stage 1: Guidance for erupting teeth and habit correction

One size

591025 T4K Soft Silc. Blue
591020 T4K Soft Silc. Green
591035 T4K Soft Silc. Pink



T4K stage 2: Arch expansion and continue habit correction

One size

591000 T4K Hard Rood



TRAINER FOR BRACES - T4B®

The Trainer System™

GEMENGD GEBIT 8-12 jaar

De T4B helpt bij het corrigeren van myofunctionele gewoonten die ervoor zorgen dat de tanden en kaken zich verkeerd ontwikkelen. Het gaat hierbij om myofunctionele gewoonten zoals tongduwen, verkeerd slikken en mondademhaling. Dit verbetert de effectiviteit en stabiliteit van de orthodontische behandeling.



T4B stage 1: Improves comfort and stability during braces treatment

One size

594000 T4B Soft Silc. Clear

594010 T4B Soft Silc. Orange



T4B stage 2: Corrects arch form during braces treatment

One size

594050 T4B Soft Silc. Clear

594051 T4B Soft Silc. Blue

DENTITION MIXTE 8-12 ans

Le T4B permet de corriger les habitudes myofonctionnelles qui entraînent un développement incorrect des dents et des mâchoires. Il s'agit notamment d'habitudes myofonctionnelles telles que la poussée de la langue, la déglutition incorrecte et la respiration buccale. Cela améliore l'efficacité et la stabilité du traitement orthodontique.

TRAINER FOR ALIGNMENT - T4A®

The Trainer System™

PERMANENT GEBIT 12-15+ jaar

De T4A® is vergelijkbaar met de T4K®, maar ontworpen voor het blijvende gebit. Hij heeft hogere zijkanten in de hoektandregio om doorbrekende hoektanden uit te lijnen en de distale uiteinden zijn langer om plaats te bieden aan de tweede molaren. De combinatie van labiale bogen en tandkanalen met het hardere Phase 2 polyurethaan materiaal zorgen voor een goede uitlijning van de anterieure tanden. Het Myofunctional Effect™ traint ook de orale musculatuur, waardoor het ideaal is bij retentie en kleine terugvalgevallen.



T4A stage 1: Initial appliance for habit correction

595010 T4A Soft Medium Clear

595011 T4A Soft Medium Blue

595030 T4A Soft Large Clear

595031 T4A Soft Large Blue



T4A stage 2: Dental alignment and habit correction

595020 T4A Hard Medium Clear

595022 T4A Hard Medium Red

595040 T4A Hard Large Clear

595041 T4A Hard Large Red

DENTITION MIXTE 12-15+ ans

Le T4A® est similaire au T4K®, mais conçu pour les dents permanentes. Ses côtés sont plus hauts dans la région des canines pour aligner les canines en éruption et ses extrémités distales sont plus longues pour accueillir les secondes molaires. La combinaison des arcs labiaux et des canaux dentaires avec le matériau polyuréthane Phase 2, plus dur, assure un alignement correct des dents antérieures. Le Myofunctional Effect™ entraîne également la musculature buccale, ce qui le rend idéal pour la rétention et les rechutes mineures.

MYOBRACE® FOR JUNIORS

The Myobrace® System

PRIMAIR GEBIT 3-6 jaar

Ontworpen voor: Klasse II malocclusie -
Anterieure (boven + onder) crowding -
Diepe beet - Open beet.

Myobrace® for Juniors is een drietrapsbeugel speciaal ontworpen om de ademhaling en slechte mondgewoonten te corrigeren en tegelijkertijd ontwikkelingsproblemen van de boven- en onderkaak te behandelen in het primaire gebit vanaf de leeftijd van drie jaar. Grote ademhalingsgaten aan de voorkant en de hogere verticale veerkern aan de achterkant helpt bij kinderen die chronisch mondademen en mogelijk een slaapstoornis hebben. De volgende toestellen J2, J3 worden gebruikt nadat de neusademhaling is hersteld.

Draagtijd 4-6 maanden/type apparaat

DENTITION LACTÉALE 3-6 ans

Conçu pour : Malocclusions de Classe II -
Encombrement antérieur (haut + bas) -
Supraclusion - Béance.

Myobrace® for Juniors est un système d'appareils en trois étapes spécialement conçu pour corriger la respiration et les mauvaises habitudes buccales tout en traitant les problèmes de développement des mâchoires supérieure et inférieure en denture de lait dès l'âge de trois ans. De grands trous de respiration ont été percés sur l'avant et une partie postérieure épaissie avec des ressorts pneumatiques assistent les enfants présentant une respiration buccale chronique et pouvant avoir des troubles respiratoires du sommeil. Les appareils ultérieurs J2, J3 sont utilisés après que la respiration nasale ait été restaurée.

Durée 4-6 mois/type d'appareil



J1 Stage 1: Habit Correction

- 410011** J1 Medium Blue
- 410016** J1 Medium Pink
- 410010** J1 Large Blue
- 410015** J1 Large Pink



J2 Stage 2: Arch development

- 410021** J2 Medium Blue
- 410026** J2 Medium Pink
- 410020** J2 Large Blue
- 410025** J2 Large Pink

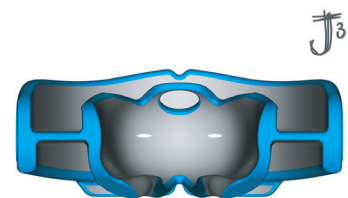

J3 Stage 3: Tooth alignment and occlusal correction

- 410031** J3 Medium Blue
- 410036** J3 Medium Pink
- 410030** J3 Large Blue
- 410035** J3 Large Pink

MYOBACE® FOR KIDS

The Myobrace® System

GEMENGD GEBIT 6-10 jaar

Ontworpen voor: Klasse II malocclusie - Anterieure (boven + onder) crowding - Diepe beet - Open beet.

Myobrace® for Kids and Teens is een systeem dat speciaal ontworpen is om ademhaling en slechte mondgewoonten te corrigeren en ontwikkelingsproblemen van de boven- en onderkaak te behandelen. Myobrace® for Kids and Teens is het meest effectief nadat de permanente voortanden van een kind zijn doorgekomen en voordat alle permanente tanden zijn doorgebroken.

Draagtijd 4-6 maanden/type apparaat

DENTITION MIXTE 6-10 ans

Conçu pour : Malocclusions de Classe II • Encombrement antérieur (haut + bas) • Supraclusion • Béance.

Myobrace® for Kids et Teens sont des systèmes d'appareils spécialement conçus pour corriger la respiration et les mauvaises habitudes buccales tout en traitant les problèmes de développement des mâchoires supérieure et inférieure. Myobrace® for Kids et Teens est le plus efficace lorsque les dents antérieures permanentes ont percé et avant que toutes les dents permanentes aient fait leur éruption.

Durée 4-6 mois/type d'appareil

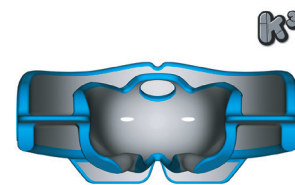

K0 Stage Zero: Establish a functional airway and habit correction

411000 K0 Medium Blue
411001 K0 Medium Clear

K1 Stage 1: Habit Correction

411145 K1 Small Blue
411150 K1 Medium Blue
411155 K1 Large Blue
411146 K1 Small Pink
411151 K1 Medium Pink
411156 K1 Large Pink

K2 Stage 2: Arch development

411215 K2 Small Blue
411220 K2 Medium Blue
411225 K2 Large Blue
411216 K2 Small Pink
411221 K2 Medium Pink
411226 K2 Large Pink

K3 Stage 3: Final alignment and retention

411370 K3 Small Blue
411380 K3 Medium Blue
411390 K3 Large Blue
411381 K3 Medium Pink

MYOBRACE® FOR TEENS

ONTWIKKELING VAN HET PERMANENTE GEBIT 10-15 jaar
 Corrigeert afwijkende mondgewoonten, behandelt ontwikkelingsproblemen van de boven- en onderkaak en lijnt de elementen uit.

LE DÉVELOPPEMENT DES DENTS PERMANENTES 10-15 ans
 Corrige les habitudes buccales anormales, traite les problèmes de développement de la mâchoire supérieure et inférieure et aligne les dents.



T1 Stage 1: Establish nasal breathing and habit correction

- 412000 T1 Medium Clear
- 412005 T1 Large Clear
- 412001 T1 Medium Blue
- 412006 T1 Large Blue

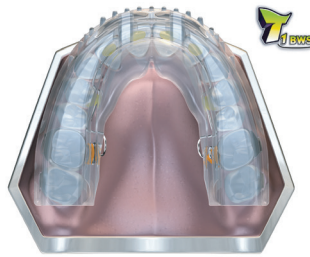

T1 BWS: Specialty, optimise BWS function and continue habit correction

- 412018 T1BWS Medium Clear



T2 Stage 2: Arch expansion and continue habit correction

- 412021 T2 Medium Clear
- 412022 T2 Large Clear



T3 Stage 3: Dental alignment

- 412031 T3 size 1 (30,0 mm.)
- 412032 T3 size 2 (31,5 mm.)
- 412033 T3 size 3 (32,5 mm.)
- 412034 T3 size 4 (33,5 mm.)
- 412035 T3 size 5 (35,0 mm.)
- 412036 T3 size 6 (36,5 mm.)
- 412037 T3 size 7 (37,5 mm.)



T3N Stage 3: Dental alignment (transitional)

- 412011 T3N size 1 (30,0 mm.)
- 412012 T3N size 2 (31,5 mm.)
- 412013 T3N size 3 (32,5 mm.)
- 412014 T3N size 4 (33,5 mm.)
- 412015 T3N size 5 (35,0 mm.)
- 412016 T3N size 6 (36,5 mm.)
- 412017 T3N size 7 (37,5 mm.)

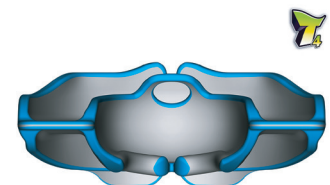

T4 Stage 4: Finalise alignment, habit correction and retention

- 412040 T4 Medium Blue
- 412041 T4 Large Blue

MYOBACE® FOR ADULTS

The Myobrace® System

ONTWIKKELING VAN HET PERMANENTE GEBIT vanaf 15 jaar

Ontworpen voor: Permanent gebit met milde tot matige malocclusie. Kan worden gevolgd door vaste apparaten of clear aligners.

Myobrace® for Adults is een drietrapsapparaat dat geschikt is voor de permanente dentitie. Bij volwassenen is de groei voltooid en is het moeilijker om gewoonten te corrigeren die orthodontische problemen veroorzaken. De Myobrace® for Adults appliance serie bevat veel van MRC's bewezen ontwerp principes, inclusief eigenschappen die slechte mondgewoonten corrigeren, terwijl lichte krachten worden uitgeoefend om de tanden uit te lijnen. Succesvolle resultaten bij volwassenen zijn minder voorspelbaar en kunnen nog steeds vaste apparatuur vereisen om een resultaat te bereiken.

DÉVELOPPEMENT DU GÉBIT PERMANENT dès l'âge de 15 ans

Conçu pour: Denture permanente avec malocclusion légère à modérée. Peut être suivi d'un appareil fixe ou de gouttières transparentes.

Myobrace® for Adults est un système d'appareils en trois étapes pour la denture permanente. Chez l'adulte, la croissance est terminée et il est plus difficile de corriger les habitudes causant les problèmes orthodontiques. La série d'appareils Myobrace® for Adults intègre nombre des principes de conception des appareils MRC, dont des dispositifs qui corrigent les mauvaises habitudes buccales tout en exerçant des forces légères pour aligner les dents. Les cas d'adultes sont moins prédictibles en termes de succès et pourront exiger des appareils fixes pour arriver à un résultat.



A1 Stage 1: Establish nasal breathing and habit correction

- 414070 A1 Medium Purple
- 414071 A1 Large Purple
- 414075 A1 Medium Clear
- 414076 A1 Large Clear



A2 Stage 2: Arch expansion and continue habit correction

- 414080 A2 Medium Purple
- 414081 A2 Large Purple
- 414085 A2 Medium Clear
- 414086 A2 Large Clear

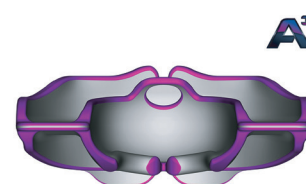

A3 Stage 3: Finalise alignment, habit correction and retention

- 414090 A3 Medium Purple
- 414091 A3 Large Purple
- 414095 A3 Medium Clear
- 414096 A3 Large Clear

MYOBACE® FOR INTERCEPTIVE CLASS III

The Myobrace® System

VOOR HET WISSELGEBIT van 6-12 jaar

Ontworpen voor: Klasse III -
Anterieure of posterieure kruisbeet

Myobrace® Interceptive Class III is een drietrapsbevestigingssysteem speciaal ontworpen om slechte mondgewoonten te corrigeren en tegelijkertijd de overmatige ontwikkelingsproblemen van de onderkaak die vaak voorkomen bij patiënten met een klasse III malocclusie. Myobrace® Interceptive Klasse III is het meest effectief in de late primaire en vroege gemengde gebitsfase (leeftijd 5 tot 8) en is verkrijgbaar in drie maten.

POUR LA DENTITION MIXTE de 6-12 ans

Conçu pour : Classe III -
Articulé croisé antérieur ou postérieur

Myobrace® Interceptive Class III est un système d'appareils en trois étapes spécialement conçu pour corriger les mauvaises habitudes buccales, tout en limitant les problèmes de développement excessif de la mandibule communément associés aux patients porteur d'une malocclusion de Classe III. Myobrace® Interceptive Class III est le plus efficace aux stades de fin de denture de lait et de début de denture mixte (5 à 8 ans) et est disponible en trois tailles.



i3^N

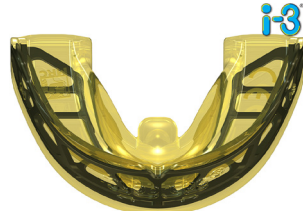

i3



P-3

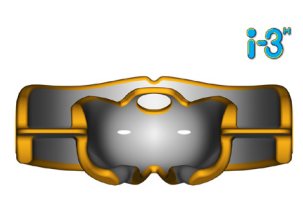

i3^H

I3N Stage 1: Habit correction

- 413055 I3N Small Yellow
- 413060 I3N Medium Yellow
- 413065 I3N Large Yellow
- 413056 I3N Small Clear
- 413061 I3N Medium Clear
- 413066 I3N Large Clear

I3 Stage 2: Arch development

- 413005 I3 Small Yellow
- 413000 I3 Medium Yellow
- 413010 I3 Large Yellow
- 413006 I3 Small Clear
- 413001 I3 Medium Clear
- 413011 I3 Large Clear

P3: Dental correction for Class III in the permanent dentition

- 413097 P3 Medium Green
- 413095 P3 Medium Clear
- 413098 P3 Large Green
- 413096 P3 Large Clear

I3H Stage 3: Finalise alignment, habit correction and retention

- 413080 I3H Medium Yellow

MYOBACE® FOR KIDS BROAD

The Myobrace® System

Voor patiënten in het wisselgebit met een genetisch brede boogvorm, van 6-10 jaar.

De Myobrace®for Kids Broad serie is een drietraps apparaat dat gebruikt wordt bij patiënten met een genetisch brede boogvorm (bijv. bepaalde groepen in Azië, Rusland en Latijns-Amerika) in het wisselgebit. Aangezien deze groep patiënten een andere boogvorm en tongvorm heeft, is het belangrijk om de Myobrace®for Kids Broad serie te gebruiken om de juiste boogvorm te bevorderen en tegelijkertijd de juiste ademhalings- en myofunctionele gewoonten te hertrainen.

Pour les patients avec une dentition mixte avec une forme d'arc génétiquement large, de 6-10 ans.

La série Myobrace®for Kids Broad est un appareil en trois étapes qui est utilisé pour les patients ayant une forme d'arc génétiquement large (par exemple, certains groupes d'Asie, de Russie et d'Amérique latine) dans leurs dentition mixte. Étant donné que ce groupe de patients a une forme d'arcade et une forme de langue différentes, il est important d'utiliser la série Myobrace®for Kids Broad pour promouvoir la forme correcte de l'arcade et en même temps pour réapprendre les bonnes habitudes respiratoires et myofonctionnelles.



K1B Stage 1: Habit correction
411170 K1B Medium Clear

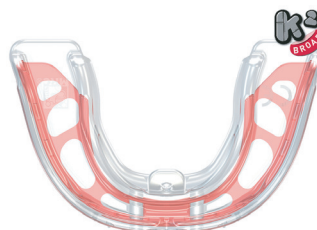

K2B Stage 2: Arch development
411180 K2B Medium Clear



K3B Stage 3: Final alignment and retention
411190 K3B Medium Clear
411191 K3B Medium Red

MYOBACE® FOR BRACES

The Myobrace® System

WISSEL - EN PERMANENT GEBIT 8+ jaar

De Myobrace®for Braces-serie is een drietraps apparaat dat wordt gebruikt bij patiënten die een behandeling met een beugel of clear aligners ondergaan, met een extra apparaat voor linguale beugels. Met speciale voorzieningen voor brackets, draad en aligners verbetert de appliance-serie de effectiviteit en efficiëntie van orthodontie door de ademhalings- en myofunctionele gewoonten aan te pakken die een orthodontische behandeling bemoeilijken.

DENTITION MIXTE ET PERMANENTE 8+ ans

La série Myobrace®for Braces est un appareil en trois étapes utilisé chez les patients qui suivent un traitement avec des brackets ou des aligneurs transparents, avec un appareil supplémentaire pour les appareils dentaires linguaux. Avec une fente spéciale dans l'appareil pour les brackets, le fil et les aligneurs, la série d'appareils améliore l'efficacité de l'orthodontie en s'attaquant aux habitudes respiratoires et myofonctionnelles qui interfèrent avec le traitement orthodontique.



B1 Stage 1: Habit correction
415000 B1 Medium Clear
415005 B1 Large Clear



B1 Lingual Stage 1: Habit correction with lingual braces
415020 B1 ling. Medium Clear

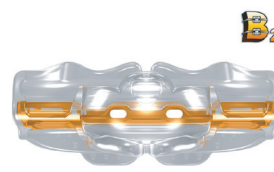

B2 Stage 2: Arch expansion and habit correction with braces
415030 B2 Med. Clear-White frame
415031 B2 Med. Clear-Orange frame
415035 B2 Large Clear-White frame
415036 B2 Large Clear-Orange frame

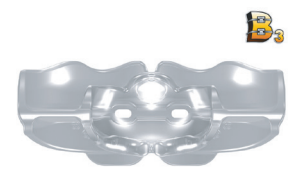

B3 Stage 3: Retention in combination with clear aligners
415040 B3 Medium Clear



MYOFUNCTIONAL SLEEP APPLIANCE

MYOSA® FOR TMJBDS®

The Myosa® System

Voor volwassenen met TMJ, ademhaling en myofunctionele stoornissen, vanaf 12 jaar.

De myOSA® is ideaal voor de behandeling van ademhalingsstoornissen tijdens de nacht. De flexibele zijanten van het apparaat met luchtveerbasis minimaliseert de impact op het TMJ, waardoor het geschikt is voor gebruikers die lijden aan TMJ-stoornissen of bruxisme. De myOSA® S1 is speciaal ontworpen voor snurkers die tijdens het slapen door hun mond ademen. De myOSA® S2 is ontworpen voor snurkers die geen chronische mondademhalers zijn of mensen die eerder met de myOSA® S1 zijn behandeld.

Pour les adultes souffrant de troubles de l'ATM, de troubles respiratoires et de troubles myofonctionnels, à partir de 12 ans et plus.

Le myOSA® est idéal pour le traitement des troubles respiratoires pendant la nuit. Les côtés flexibles de l'appareil avec base à ressort pneumatique minimisent l'impact sur l'ATM, ce qui le rend adapté aux utilisateurs souffrant de troubles de l'ATM ou de bruxisme. Le myOSA® S1 est spécialement conçu pour les ronfleurs qui respirent par la bouche pendant leur sommeil. Le myOSA® S2 est conçu pour les ronfleurs qui ne sont pas des respirateurs buccaux chroniques ou les personnes qui ont déjà été traitées avec le myOSA® S1.



S1



S1^M

S1 Stage 1: Establish a functional airway and habit correction

700000 S1 (TMJBDS)

700001 S1 (TMJBDS) mouldable



S2

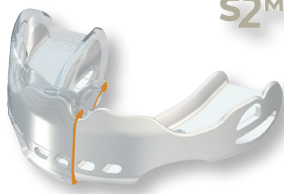

S2^M

S2 Stage 2: Transition to nasal breathing and habit correction

700005 S2 (TMJBDS)

700006 S2 (TMJBDS) mouldable

TMD AUXILIARY APPLIANCE FOR ADVANCED INTRACAPSULAR TMJ DISORDER

The Myosa® System

De Myosa®TMD is een op maat te maken apparaat dat wordt gebruikt voor patiënten met vergevorderde intracapsulaire TMJ-aandoeningen.

Het wordt de hele dag gedragen, behalve wanneer de TM-JBDS®-apparaten worden gedragen, en is ontworpen om constante decompressie van het TMJ te bieden om genezing mogelijk te maken. Het heeft speciale ontwerpkenmerken waardoor patiënten kunnen kauwen en praten met minimale verstoring.

Le Myosa®TMD est un appareil modulable a utilisé pour les patients présentant une maladie intracapsulaire avancée de l'ATM.

Il est porté toute la journée, sauf lorsque les appareils TMJBDS® sont portés, et est conçu pour fournir une décompression constante de l'ATM afin de permettre la guérison. Il présente des caractéristiques de conception spéciales qui permettent aux patients de mâcher et de parler avec un minimum de perturbation.

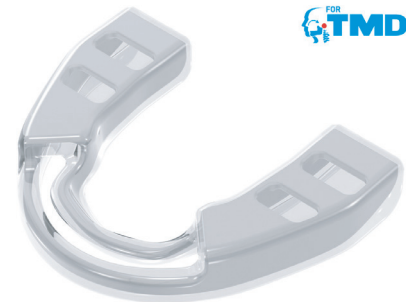

FOR TMD

TMD
703010 TMD
703011 TMD (low version)

MYOSA® FOR TEETH GRINDERS

The Myosa® System

Bescherming van de tanden tegen het knarsen, vanaf 12 jaar.

De Myosa® voor tandenknarsers is een op maat te maken apparaat die bescherming biedt tegen knarsetanden en is ontworpen voor patiënten die op zoek zijn naar een onmiddellijk en kosteneffectief alternatief voor op maat gemaakte tandheelkundige toestellen.

Protection des dents contre le grincement, à partir de 12 ans et plus.

Le Myosa® teeth grinder est un appareil moulable sur mesure qui protège les dents contre le grincement et qui est conçu pour les patients qui recherchent une alternative immédiate et rentable aux appareils dentaires sur mesure.



TG
SOFT VERSION

TG - Soft Version
703030 TG



TG^H
HARD VERSION

TG - Hard Version
703035 TGH



A revolution in active myofunctional appliance therapy

VOOR ALLE LEEFTIJDEN

De Myotalea®-reeks is ontwikkeld om de kracht en tonus van de tong-, lip-, kaak- en luchtwegspieren te optimaliseren.

POUR CHAQUE AGE

La gamme Myotalea® est conçue pour optimiser la force et le tonus des muscles de la langue, des lèvres, des mâchoires et des voies respiratoires.

MYOTALEA TONGUE, LIP & JAW - TLJ

Improvement of tongue, lip, jaw and airway muscle strength

Het toestel heeft meerdere functies die het mogelijk maken al deze spieren in één toestel te oefenen. De TLJ wordt gebruikt als een aanvullend actief myofunctioneel oefentoestel in alle behandelssystemen van MRC, maar kan ook op zichzelf worden gebruikt door beoefenaars die myofunctionele therapie geven.

L'appareil a plusieurs fonctions qui permettent d'exercer tous les muscles dans un seul appareil. Le TLJ est utilisé comme un appareil d'exercice myofonctionnel actif complémentaire dans tous les systèmes de traitement de MRC, mais il peut également être utilisé seul par les praticiens proposant une thérapie myofonctionnelle.

The Myotalea® System



- 710005 TLJ® Soft Silc. Small Clear
- 710000 TLJ® Soft Silc. Medium Clear
- 710010 TLJ® Soft Silc. Large Clear

MYOTALEA TONGUE & LIP PRESS - TLP

Targeted improvement of the tongue, lip and airway muscles

De TLP richt zich op het verbeteren van de kracht en tonus van de tong, lip en luchtwegspieren.

Le TLP se concentre sur l'amélioration de la force et du tonus de la langue, des lèvres et des muscles respiratoires .

The Myotalea® System

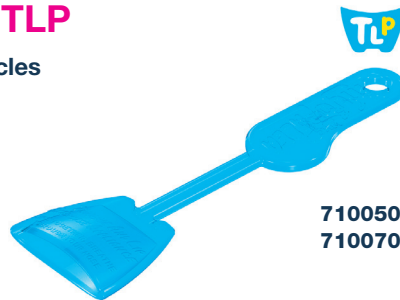

- 710050 TLP Soft Silc. Blue
- 710070 TLP Hard Blue

LIP TRAINER™ - LT

Improvement of swallowing and peri-oral muscle function

De LT richt zich op het verbeteren van de kracht, de rek en de tonus van de lip- en wangspieren, terwijl tegelijkertijd het slikken van de patiënt wordt hertraind.

Le LT se concentre sur l'amélioration de la force, de l'étirement et du tonus des muscles des lèvres et des joues, tout en réentraînant la déglutition du patient.

The Myotalea® System



- 590500 Lip Trainer Soft Silc. Blue
- 590505 Lip Trainer Soft Silc. Pink
- 590510 Lip Trainer Soft Silc. Clear

CLEANING TABLETS

Myoclean™ is het aanbevolen reinigingsmiddel voor alle MRC-toestellen. Mag 2x per week gebruikt worden. Kan ook gebruikt worden voor aligners of andere uitneembare beugels.

Myoclean™ est le produit de nettoyage recommandé pour tous les appareils MRC. Peut être utilisé 2 fois par semaine. Peut également être utilisé pour les aligneurs ou d'autres appareils amovibles.

301224 MYOCLEAN per pack 12 boxes x 24 tablets, English
301212 MYOCLEAN per pack 12 boxes x 12 tablets, English



TRAINER ACTIVITIES WORKBOOK & DVD



40: Trainer Activiteiten
Werkboekjes
12 stuks + DVD - ENG

40 - FR: Livrets d'Activités
12 pcs + DVD - FR



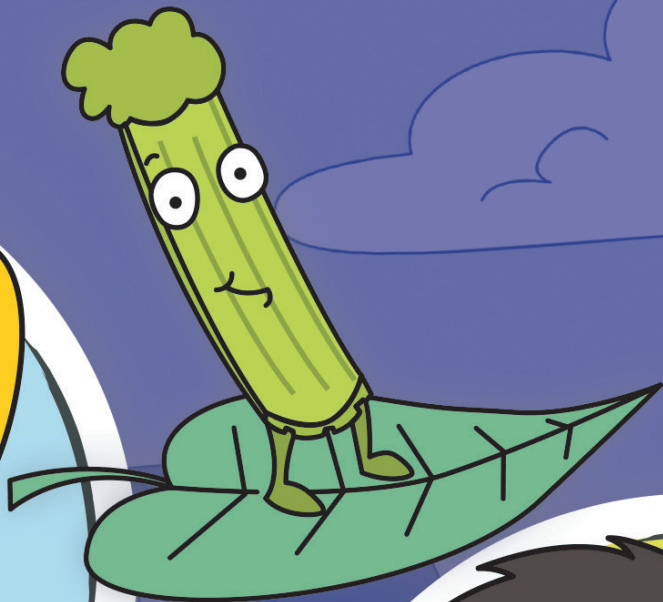

myobrace[®]

For more information, visit www.myobrace.com
MYOBACE[®] BY MYOFUNCTIONAL RESEARCH CO.



Afdruk materiaal/ Matériel pour empreintes

CAVEX CREAM ALGINATE FAST SET

- 5 µm detailweergave
- Hoge scheursterkte en elasticiteit
- Settingtijd in de mond 1 min
- Scanbaar

- 5 µm vue détaillée
- Résistance à la déchirure et élasticité élevées
- Temps de prise en bouche 1min.
- Numérisable

AA605-20
Economy pack
20x 500gr

AA605-1
1x 500gr



CAVEX ORTHOTRACE

- 25 µm detailweergave
- Hoge scheursterkte en elasticiteit
- Settingtijd in de mond 1 min

- 25µm vue détaillée
- Résistance à la déchirure et élasticité élevées
- Temps de prise en bouche 1min.

AA380-20
Economy pack
20x 500gr

AA380-1
1x 500gr



CAVEX ALGINATE MIXER 3

De Cavex Alginate Mixer 3 is het ideale apparaat om een homogene algiinaat mix te creëren, wat leidt tot de perfecte algiinaatafdruk

Kenmerken

- Een perfecte algiinaat mix in slechts zes tot acht seconden
- Eenvoudige en intuïtieve bediening
- Onderhoudsvrij dankzij verbeterde technologie
- Vier verschillende programma's
- Altijd zeker van een perfecte afdruk
- Modern design, een pronkstuk in iedere praktijk

Met het innovatieve, gebruiksvriendelijke touchscreen kan met één druk op de knop het gewenste programma worden geselecteerd:

- Extra Fast Set algiinaat
- Fast Set algiinaat
- Normal Set algiinaat
- Gips

AT544
Cavex Alginate Mixer 3
incl 10x500g Orthotrace



Le mélangeur d'alginate Cavex 3 est l'appareil idéal pour créer un mélange homogène d'alginate,

Caractéristiques

- Un mélange parfait d'alginate en seulement six à huit secondes
- Utilisation simple et intuitive
- Sans entretien grâce à une technologie améliorée
- Quatre programmes différents
- Toujours sûr d'une empreinte parfaite
- Un design moderne

Grâce à l'écran tactile innovant et convivial, le réglage souhaité peut être sélectionné par simple pression sur un bouton. Le programme souhaité en appuyant sur un bouton :

- Alginate à prise ultra rapide
- Alginate à prise rapide
- Alginate à prise normale
- Plâtre

CAVEX WATER DOSING BOTTLE



AT021

CAVEX ALGINATE MIXER SPATULA & STICK



AT511

Cavex Alginate Mixer plastic spatula

AT513

Cavex Alginate Mixer plastic stirrer stick

CAVEX ALGINATE MIXER MIXING BOWL



AT530

CAVEX MIXING BOWL BLUE & SPATULA



AT041

Cavex mixing bowl blue

AT042

Cavex mixing spatula, plastic

AT060

Cavex mixing spatula, metal

AFDRUKLEPELS / PORTE-EMPREINTES



700-220

Upper (10/pk)



700-224

Upper (10/pk)



700-228

Upper (10/pk)



700-232

Upper (10/pk)



700-236

Upper (10/pk)



700-240

Upper (10/pk)



700-250

Assortment
kit (36/pk)

700-222

Lower (10/pk)

700-226

Lower (10/pk)

700-230

Lower (10/pk)

700-234

Lower (10/pk)

700-238

Lower (10/pk)

700-242

Lower (10/pk)



CAVEX ALGINATE CONTAINER



AT240
Cavex alginate container blue

AT260
Cavex alginate container pink

CAVEX ALGINATE ADHESIVE



AB010
Cavex alginate adhesive 2x14ml

CAVEX GREENCLEAN

Verwijder alginat- en gipsresten eenvoudig en snel in 30 min.

Éliminez les résidus d'alginate et de plâtre facilement et rapidement avec Cavex GreenClean.



HA001
Cavex GreenClean 1kg

CAVEX IMPRESAFE

Een snel, veilig en zeer effectief afdrukdesinfectiemiddel.

In slechts drie minuten doodt de revolutionaire desinfectievloeistof 99,99% van alle bacteriën, schimmels en virussen, waaronder het coronavirus. Het is een compleet systeem voor de tandartspraktijk dat bestaat uit:

- Een desinfectiecontainer
- Een liter desinfectieconcentraat
- Een digitale timer

Cavex ImpreSafe, élimine 99,999% de tous les virus, bactéries et champignons.

Partant des caractéristiques connues à ce jour, nous supposons donc que le coronavirus est très probablement éliminé par le Cavex ImpreSafe. Nous précisons que cela concerne l'utilisation du Cavex ImpreSafe sur des empreintes en alginate, silicone et polyéther.



HA050
Cavex ImpreSafe 6 x 1L

HA050-1
Cavex ImpreSafe 1 x 1L

GC EXAFLEX PUTTY & EXAMIX NDS



GC IMPRESSION SEPARATION WAFER



AFDRUK in 1 fase

- Breng de Exaflex putty in de geperforeerde afdrukepel
- Maak een gleuf en injecteer de Examix NDS

AFDRUK in 2 fase

- Breng de Exaflex putty in de geperforeerde afdrukepel
- Plaats een Separation wafer op de putty en neem de afdruk
- Verwijder de Separation wafer na de afdruk genomen te hebben
- Injecteer de Examix NDS en neem opnieuw een afdruk

Pakket

- Putty1-1pak (500g lichtblauwe basis + 500g gele katalysator), **138801**
- Examix NDS Injection, pak van 2 cartridges + mengnaalden, **137106**
- Cartridgedispenser, **800006**
- Separation Wafers 30 pcs, **800099**

EMPREINTE en une phase

- Mettez l'Exaflex Putty dans un porte-empreinte perforé
- Créez une fente et injectez l'Examix NDS

EMPREINTE en deux phases

- Insérer le mastic Exaflex dans le porte-empreinte perforé
- Placez une feuille d'espaceur sur le mastic et prenez l'empreinte.
- Retirer une feuille d'espaceurs après l'empreinte
- Injecter l'Examix NDS et reprendre un empreinte.

Paquet

- Putty1-1 (base bleue 500 g & catalyseur jaune 500 g), **138801**
- Examix NDS Injection, coffret de 2 cartouches + embouts mélangeurs, **137106**
- Cartridge Dispenser (distributeur de cartouche), **800006**
- Separation Wafers 30 pcs, **800099**



Fotografie/ Photographie





PhotoMED SDL

Smartphone Dental Light



De PhotoMed SDL is het perfecte tandheelkundige accessoire voor uw smartphone. De SDL beschikt over twee hoge CRI 95 + LED panelen die 8 niveaus van helderheid hebben. De laagste helderheidsstand is ideaal voor tandheelkundige fotografie en de ingebouwde lithium-ion batterijen gaan meer dan 12 uur ononderbroken mee.

Gemakkelijke verbinding met uw smartphone via het bluetooth systeem. Gebruik de gewenste app op uw smartphone en maak de mooiste foto's met de PhotoMed SDL door de juiste belichting.

Le PhotoMed SDL est l'accessoire dentaire parfait pour votre smartphone. Le SDL est équipé de deux panneaux CRI 95+ et LED qui ont 8 niveaux de luminosité. Le réglage de luminosité le plus faible est idéal pour la photographie dentaire et les batteries lithium-ion intégrées ont une durée de 12 heures sans interruption.

Une connexion facile avec votre smartphone via le système bluetooth. Utilisez l'application de votre choix sur votre smartphone ! Prenez les meilleures photos avec le PhotoMed SDL grâce au bon éclairage.



DI-SDL
Smartphone
Dental Light



*en nog zoveel andere apps /
et tant d'autres applications*



CROSS POLARIZATION FILTER

For Smart Phone Dental Light

De cross polarisatie filter verwijdert alle reflecties op de tanden die worden veroorzaakt door de lichtbron. De gepolariseerde foto's zorgen ervoor dat u als orthodontist kan aantonen dat de tandafwijkingen, zoals white spots, er al waren voordat de behandeling begon.

Le filtre de polarisation croisée élimine toutes les réflexions sur les dents qui sont causées par la source de lumière. Les photos polarisées vous permettent, en tant qu'orthodontiste, de prouver que les anomalies dentaires, telles que les taches blanches, existaient déjà avant le début du traitement.



DI-SDLCPF
Cross Polarization Filter for
Smart Phone Dental Light

Doctors^{eyes}mirrors ultrabright mirrors

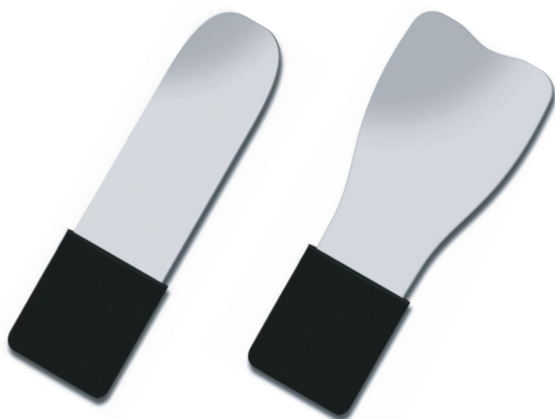

Buccal mirror

Occlusal mirror

- Bijna 100% reflectie!
- Beste anatomische vormgeving en oppervlakte reflectie
- Afneembare, steriliseerbare siliconen handgreep

- Une image réfléchi à presque 100%
- La meilleure forme anatomique et réflexion
- Manche en silicone, amovible et stérilisable

860031

Occlusal mirror no. 11

- Child size
- Width 55mm
- Thickness 3 mm

860045

Occlusal mirror no. 12

- Adult size
- Width 65mm
- Thickness 3 mm

860032

Occlusal mirror no. 13

- Adult size
- Width 70mm
- Thickness 3 mm

860046

Buccal mirror no. 15

- Unique size
- Width 40mm
- Thickness 3 mm

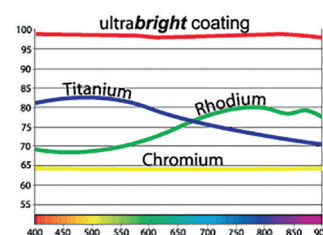



FOGFREE MIRROR WARMER 860105

De FogFree Mirror Warmer is ontworpen om uw intra-orale spiegels op lichaamstemperatuur te brengen en te voorkomen dat ze aandampen. Zet de verw warmer aan ongeveer 20-30 minuten voor het gebruik en maak mistvrije foto's.

Le réchauffeur de miroir FogFree est conçu pour amener vos miroirs intra-oraux à la température du corps et les empêcher de s'embuer. Mettez le chauffe-miroir en marche environ 20 à 30 minutes avant l'utilisation.



Mist-free Photomirrors stainless steel mirrors

ECONOMIE kit - PMDECO-03 bestaande uit:

- Spiegelhouder
- Lithium-ion batterij en oplader
- Gebruiksaanwijzing
- 1 fotospiegel naar keuze

Kit ECONOMIQUE- PMDECO-03 comprenant:

- Manche à miroir
- Chargeur et batterie lithium
- Mode d'emploi
- 1 Miroir au choix

Product details:

- Stainless steel photo mirror
- Front surface mirror, both sides
- Completely Sterilizable up to 134°C
- Can be used in ultrasonic bath

Product details:

- Stainless steel photo mirror
- Front surface mirror, both sides
- Completely Sterilizable up to 134°C
- Can be used in ultrasonic bath



- Geen aandamping door ventilatiesysteem
- Luchtvolume kan worden verhoogd of verlaagd
- Spiegel wordt verlicht met 2 LED lampjes
- Eenvoudige één-schroef-fixatie van de spiegel
- In combinatie met [Stainless Steel spiegels](#)

- Pas de buée grâce au système de ventilation
- La ventilation peut-être adaptée
- Le miroir est éclairé par 2 lampes LED
- La fixation du miroir est facile
- En combinaison avec [des miroirs en acier](#)



FSFDM-03
Occlusal, adults
Width - 70mm / 62.5mm
Length - 139.0mm

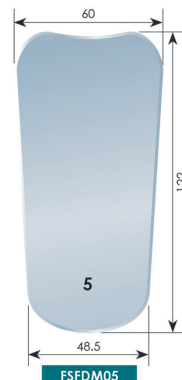

FSFDM-05
Occlusal, children
Width - 60mm / 48.5mm
Length - 122mm

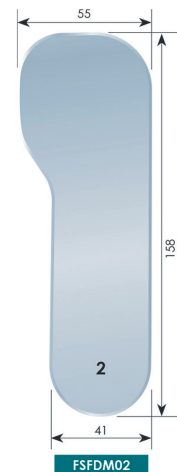

FSFDM-02
Lateral, adults
Width - 41mm x 55mm
Length - 158mm



CHEEK RETRACTORS

- Mag in de autoclaaf
- Verkrijgbaar per stuk

-
- Peut être autoclavé
 - Disponible par pièce

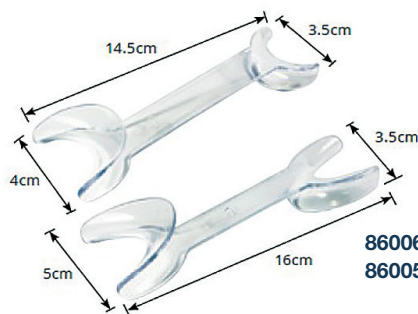

860129 Black Small
860130 Black Large

860062 Clear Small 4cm-3,5cm
860057 Clear Large 5cm-3,5cm



LIP RETRACTOR

- Mag in de autoclaaf tot 121°C, of koud steriliseren
- Materiaal medical grade Polycarbonate

-
- Autoclave jusqu'à 121°C, ou stérilisation à froid.
 - Matériau : Polycarbonate de qualité médicale



860132 small

860104 large

LIP RETRACTOR

- Per stuk verkrijgbaar

-
- Disponible par pièce



600-035 Small 7x16cm
600-034 Large 8,5x16cm

METALLIC BLADES MIRRORS

- Mag in de autoclaaf tot 137°C
- Per stuk verkrijgbaar

-
- Peut être autoclavé jusqu'à 137°C.
 - Disponible par pièce

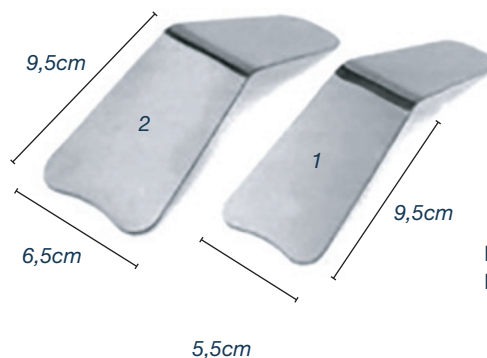

DB04-0165/1 Small mirror (1)
DB04-0165/2 Large mirror (2)



Patiënt Supplies/ Produits pour patients



ORTHO EASE TRAVEL KIT

- Ortho Tandborstel
- Ortho Reisborstel
- 10m Nylon Flosdraad
- Interdentale Borstel
- 10st Tandflosdraad Threader
- Orthowas in Plastic Etui
- Spiegel
- Twee minuten timer
- Doos van 10 zakjes/kleur

- Brosse à dents Ortho
- Brosse de voyage Ortho
- 10m de fil de nylon
- Brosse interdentaire
- 10 pcs enfileur de fil dentaire
- Cire ortho dans un étui en plastique
- Miroirs
- Minuterie de deux minutes
- Boîte de 10 pochettes/couleur

DB04-4260 Blue
DB04-4261 Red
DB04-4262 Green
DB04-4263 Purple



ORTHO EASE CHEWIES



DB04-4231
Aligner Chewies
plain unscented (2 x 10 pcs)

DB04-4230
Aligner Chewies
Mint (2 x 10 pcs)

ORTHODONTIC RELIEF WAX



RW40113
Patient Relief Wax Plain
Silver - 50 pcs

700-104 Patient Relief Wax Plain
White - 50 pcs

ORTHO EASE RETRIEVERS

DB04-4220 - verpakt per 10 stuks



GC MI PASTE PLUS

Weg met de white spots. Met de GC MI Paste Plus beschermt u uw patiënt!
De combinatie van fluoride, calcium en fosfaat vormt een sterke beschermlaag. De neutrale pH-waarde van 6,6 maakt het tandglazuur beter bestand tegen zuren en verhindert demineralisatie.

GC Mi Paste Plus: **462886** aarbei - **462621** munt

Fini avec les white spots! Avec GC MI Paste Plus vous pouvez protéger votre patient.

L'association du fluorure, du calcium et des phosphates forme une forte couche protectrice. La valeur de pH neutre de 6.6 rend l'émail des dents plus résistant aux acides et empêche la déminéralisation.

GC Mi Paste Plus: **462886** fraise - **462621** menthe



CAVEX RUSH BRUSH

Kenmerken

- Geïmpregneerd met tandpasta, direct bruikbaar
- Hygiënisch verpakt
- Gemakkelijk mee te nemen
- Frisse muntsmaak
- Veilige, zachte borstel
- Kleine borstelkop voor precisie

Caractéristiques

- Imprégné de dentifrice, directement utilisable
- Emballage hygiénique
- Facile à emporter
- Goût frais de menthe
- Brosse douce
- Petite tête de brosse pour la précision



HA090
Cavex Rush Brush - 1 x 100 pcs

CAVEX BITE&WHITE ABC MASTERKIT

Met de ABC Masterkit biedt Cavex de enige driestaps-bleekoplossing om veilig, effectief en vooral pijnloos de tanden te bleken.

Inhoud Cavex Bite&White ABC Masterkit:

- 1 tube Cavex Bite&White StainLess 50 g/35 ml
- 3 x Cavex Bite&White 3 ml spuit
- 1 tube Cavex Bite&White ExSense tooth conditioner 50 g/42 ml
- 1 bewaardoosje, 1 shade-guide, 1 instructiehandleiding

Avec le kit ABC Master, Cavex propose la seule solution de blanchiment en trois étapes, pour un blanchiment des dents sûr, efficace et surtout indolore.

Contenu Cavex Bite&White ABC Master Kit :

- 1 tube Cavex Bite&White StainLess 50 g/35 ml
- 3 x Cavex Bite&White seringues de 3 ml
- 1 tube Cavex Bite&White ExSense conditionneur de dents 50 g/42 ml
- 1 boîte de rangement, 1 guide des teintes, 1 manuel d'instruction



BW090 Cavex
Bite&White
ABC Masterkit



CAVEX BITE&WHITE SYRINGE

BW007 Cavex Bite&White - 3 syringes

BW015 Cavex Bite&White bulk pack syringe - 10 syringes



CAVEX TOOTH WHITENING PEN

BW080

Geen bleach retainer nodig! Rechtstreeks aan te brengen op de tanden dmv het penseel! 20-30 sessies van 15 min.

Pas besoin d'une gouttière de blanchiment! Peut être appliqué directement sur les dents avec le pinceau! 20-30 sessions de 15 min.



RETAINER CASES



Retainer Boxes	Mini 1"	Max 1.5"
Sparkle Aqua	DB04-4001	DB04-4101
Tropical Pink	DB04-4007	DB04-4107
Sparkle Black	DB04-4002	DB04-4102
Tropical Orange	DB04-4008	DB04-4108
Tropical Blue	DB04-4009	DB04-4109
Sparkle Green	DB04-4004	DB04-4104
Tropical Green	DB04-4010	DB04-4110
Sparkle Purple	DB04-4005	DB04-4105
White Splash	DB04-4012	DB04-4112
Sparkle Red	DB04-4006	DB04-4106
White	DB04-4014	DB04-4114
Sparkle Assorted (excludes white splash and white)	DB04-4000	DB04-4100

2 sizes:

- Mini 1" Retainer Boxes
- Max 1.5" Retainer Boxes

Sold in packs of 10 (1 colour or sparkle assorted)

ELASTIC ATTACER



100/pkg.
800-026

ELASTIC STORAGE KEY RINGS



50/pkg.
Neon assorted **ESC050**
Basic assorted **ESC150**

PONTIC WAX

PONTIC WAX Pack of 10

Creates the appearance of teeth inside aligners with areas of missing teeth/tooth. Easy to apply and remove when needed. If the pontic wax wears down during treatment it can easily be replaced by the patient in between appointments.



CLEANING TABLETS

Myoclean™ is het aanbevolen reinigingsmiddel voor alle uitneembare apparaten en sportbeugels. Mag 2x per week gebruikt worden. Kan ook gebruikt worden voor aligners of andere uitneembare beugels.

Myoclean™ est le produit de nettoyage recommandé pour tous les appareils amovibles et protèges-dents. Peut être utilisé 2 fois par semaine. Peut également être utilisé pour les aligneurs ou d'autres appareils amovibles.

301224 MYOCLEAN per pack 12 boxes x 24 tablets, English

301212 MYOCLEAN per pack 12 boxes x 12 tablets, English



opro MOUTHGUARDS FOR BRACES

The OPRO Gold Braces Mouthguard is specially designed for wearers of fixed braces.



OPR-102511001 OPRO Mouthguard Black / Gold - 1 pc

OPR-102511002 OPRO Mouthguard White / gold - 1pc

OPR-102506002 OPRO Mouthguard Blue / Pearl - 1 pc

OPR-102506003 OPRO Mouthguard Red / Pearl - 1pc

ORTHO EASE ORTHODONTIC TRAVEL TOOTHBRUSH

DB04-4250 - verpakt per 12 stuks /
emballé par 12 pièces



ORTHO EASE ORTHODONTIC TOOTHBRUSH

DB04-4240 - verpakt per 12 stuks /
emballé par 12 pièces



WAXED FLOSS

Johnson&Johnson / 200m

100000045





Hygiène/ Hygiène

SURGICAL MASKS DM01-311-01-IIR

- Chirurgische mondkmaskers Type IIR, 3- laags, voorzien van neusstrip
- Verpakt per 50 stuks/box

-
- Masques buccaux chirurgicaux de type IIR, 3 couches, avec bandelette nasale
 - Emballage par 50 pcs/boite



FFP2 MASKS DM9501

- Dit FFP2 fijnstof mondkmasker beschermt tegen schadelijke stoffen (bv. bij Corona, Sars, TBC en MRSA), rook en op water en olie gebaseerde aerosolen.
- Het mondkapje is voorzien van een zachte afdichting in het neusprofiel en zit comfortabel
- Cup-vorm
- Voorzien van elastiekjes en een flexibele neusstrip.
- Verpakt per 20 stuks/box

-
- Ce masque contre les poussières fines FFP2 vous protège contre les substances nocives (par exemple Corona, Sars, TBC et MRSA), la fumée et les aerosols a base d'eau et d'huile.
 - Le masque buccal a un joint souple dans le profil nasal et est confortable a porter.
 - Forme de bec
 - Equipé d'élastiques et d'une bande
 - Emballage de 20 pcs/box



CAVEX ORAL PRE RINSE

Een mondspoelmiddel ter voorbereiding op de behandeling.

- Bevat 1,5% waterstofperoxide (doodt virussen, o.a. COVID-19)
- Direct klaar voor gebruik
- Al effectief bij 30-60 seconden spoelen
- Patiëntvriendelijk door de prettige muntsmaak
- Inhoud van 500 ml voor zo'n 50 doseringen
- Fles voorzien van geïntegreerde doseerbeker

Un bain de bouche en préparation du traitement.

- Contient 1,5% de peroxyde d'hydrogène (tue les virus, y compris COVID-19)
- Prêt à l'emploi
- Efficace dès 30-60 secondes de rinçage
- Le goût de menthe est agréable pour le patient
- Contenu de 500 ml pour environ 50 dosages
- Bouteille avec gobelet doseur intégré



MW001 6x500ml

CAVEX IMPRESAFE

HA053 Starterkit HA050-1 Refill 1L

Cavex ImpreSafe, doodt 99,999% van alle virussen, bacteriën en schimmels. Afgaande op de tot op heden bekende karakteristieken verwachten wij dat het Corona-virus zeer waarschijnlijk gedood wordt door Cavex ImpreSafe. Wij benadrukken dat dit betrekking heeft op het gebruik van Cavex ImpreSafe op alginaat-, siliconen- en polyetherafdrukken.

Cavex ImpreSafe, élimine 99,999%; de tous les virus, bactéries et champignons. Partant des caractéristiques connues à ce jour, nous supposons donc que le coronavirus est très probablement éliminé par le Cavex ImpreSafe. Nous précisons que cela concerne l'utilisation du Cavex ImpreSafe sur des empreintes en alginate, silicone et polyéther



SHARPSAFE CONTAINER 1L

SHA-41602610

Voor prikkend medisch afval ook voor brackets/banden en draden

Kenmerken

- Gele container met doorschijnend deksel
- Vlotte montage door eenvoudige druk met vergrendelingsklik: 4 'klikken'
- Aanduiding van de maximale vulstand
- Afmetingen container in mm H x L x B in mm: 187 x 108 x 90

Pour les déchets médicaux perforants également pour les brackets / bagues et fils

Caractéristiques

- Récipient jaune avec couvercle translucide
- Installation facile par simple clic sur un bouton-poussoir: 4 «clics»
- Indication du niveau de remplissage maximum
- Dimensions bac en mm H x L x L en mm: 187 x 108 x 90



COTTON HEAD CAP

HEAD CAP BLUE HEAD CAP WHITE

- Materiaal: Katoen
- Size: one size fits all

- Matière: Coton
- Taille: une taille unique



comforties **SOFT NITRIL PREMIUM**

Comforties soft nitril Premium handschoenen zijn gemaakt met de nieuwste productietechnieken en bieden de benodigde bescherming samen met dat vertrouwde "latexachtige gevoel" van comfort en beweeglijkheid.



ELASTISCH, DUN EN STERK !

Maten XS/S/M/L

- 1 doos bevat 100 handschoenen
- Kleur: wit en violetblauw

Violet Blue : **7900 XS- 8000 S - 8100 M - 8200 L**

White : **7900W XS- 8000W S - 8100W M - 8200W L**

Les gants médicaux Premium en nitrile, fabriqués conformément aux techniques de production les plus avancées procurent la protection nécessaire et la sensation connue de confort et de la touche précise des gants en latex.

ELASTIQUE, FIN et RESISTENT !

Tailles XS/S/M/L

- 1 boîte contient 100 gants
- Couleur : blanc et violet bleu

INSTRUMENTENHOUDER SYSTEEM

Het innovatieve instrumentenhouder systeem voor uw thermodesinfector

- Verbetert het reinigings- en desinfectieproces
- Draagt bij aan een optimaal droogresultaat
- Is geschikt voor een complete behandelset
- Zorgt voor een opgeruimde en overzichtelijke werkplek
- Vermindert het aantal contactmomenten met de instrumenten
- Verbetert de veiligheid van het personeel en patiënt
- Maakt het gebruik van trays overbodig
- Verbetert en versnelt de gehele routing in uw praktijk
- Versnelt en vereenvoudigt het beladen en ontladen van de reinigings- en desinfectiemachine
- Bij juist gebruik verdient het systeem zichzelf terug.

SYSTÈME DE PORTE-INSTRUMENTS

Le système innovant de porte-instruments pour votre thermodésinfecteur

- Améliore le processus de nettoyage et de désinfection
- Contribue à un résultat de séchage optimal
- Convient pour un ensemble complet de traitements
- Garantir un lieu de travail propre et dégagé
- Réduit le nombre de moments de contact avec les instruments
- Améliore la sécurité du personnel et des patients
- Rend l'utilisation de plateaux superflue
- Améliore et accélère le flux dans votre cabinet
- Accélère et simplifie le chargement et le déchargement de la machine de nettoyage et de désinfection
- Lorsqu'il est utilisé correctement, le système s'amortit

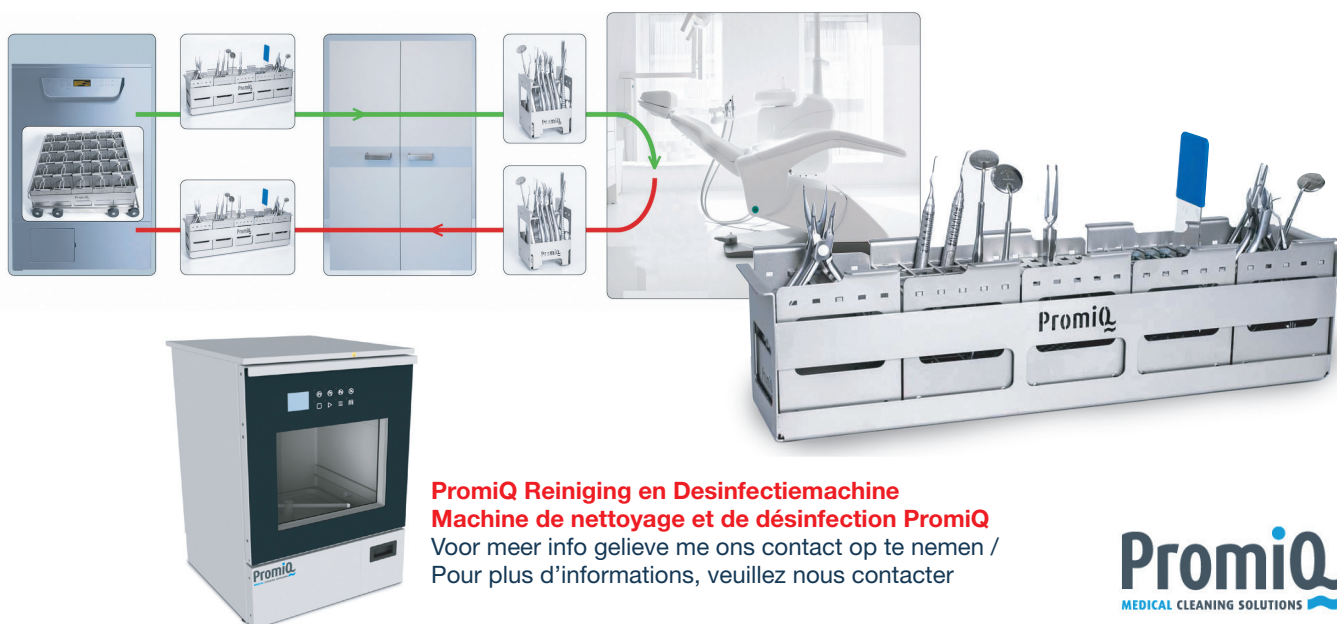

PromiQ Reiniging en Desinfectiemachine

Machine de nettoyage et de désinfection PromiQ

Voor meer info gelieve me ons contact op te nemen /
Pour plus d'informations, veuillez nous contacter

PromiQ
MEDICAL CLEANING SOLUTIONS

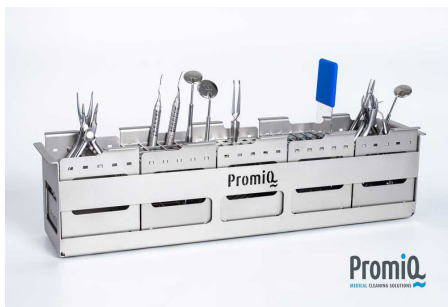
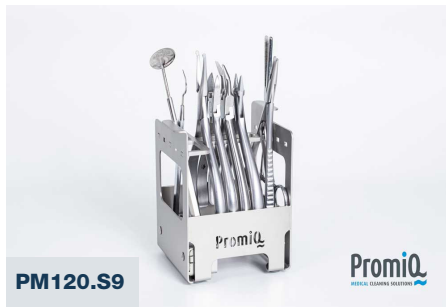

PromiQ
MEDICAL CLEANING SOLUTIONS



Labo producten/ Produits labo



MINISTAR® S 3501.1

- Power: 230 V, 750 W
- Persdruk : 0.5 - 4.0 bar
- Afmetingen (W x H x D): 500 x 210 x 400 mm
- Gewicht: 9 kg
- 3 jaar garantie

Scanner aanwezig! Dankzij de barcode op de plaat wordt alles automatisch ingesteld (instelling van de tijd, duur van opwarming, afkoeling en temperatuur)



- Puissance : 230 V, 750 W
- Pression: 0.5 - 4.0 bar
- Dimensions (L x H x P) : 500 x 210 x 400 mm
- Poids : 9 kg
- 3 ans de garantie

Scanner disponible! Grâce au code-barre sur la plaque, tout est automatique (réglage de l'heure, durée de chauffage, refroidissement et température)

MINISTAR S® Protection cover

3447 1 pc
Protection Cover



PELLET COVER

3006 5 pcs Large
3007 5 pcs Small



STAINLESS STEEL PELLETS

3222
1x 1kg Pellets



DURAN®

Duran 1 mm
3415.1 10 pcs
3415.2 100 pcs
Duran 1,5 mm
3417.1 10 pcs
3417.2 100 pcs



ISOFOLAN®

3207.1 100 pcs



DURASOFT®PD

DURASOFT pd 1.8mm
3388.1 10 pcs
3388.2 100 pcs
DURASOFT pd 2.5mm
3387.1 10 pcs
3387.2 100 pcs



BIOPLAST® bleach

3190.1 10 pcs
3190.2 100 pcs



BIOPLAST® mouth guards, positioners



3282.1 3mm
RED 10 pcs

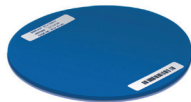

3354.1 3mm
AZURE BLUE 10 pcs



3356.1 3mm
TRANSPARANT BLUE 10 pcs

3445.1 3mm
WHITE 10 pcs
3448.1 3mm
BLACK 10 pcs
3187.1 3mm
CLEAR 10 pcs



CA® PRO

CA® Pro kan gebruikt worden als onafhankelijk aligner materiaal of binnen het 3-splint systeem van het CA® protocol.

CA® Pro is bestemd voor de vervaardiging van spalken en aligners voor de correctie van malocclusie. De optimale aanvangskracht en uitstekende veerkrachteigenschappen maken CA® Pro ideaal voor kortdurende toepassingen in de moderne orthodontische behandeling...

- Hoge elasticiteit en breukvastheid dankzij een flexibele elastomeer laag
- Continue krachtoverbrenging, minimaal krachtverlies
- Hoog draagcomfort dankzij zachte aanvangskracht
- Ook verkrijgbaar: CA® Pro+ met geïntegreerde isolatiefolie

CA® Pro peut être utilisé comme un matériau d'alignement indépendant ou dans le cadre du protocole CA®.

CA® Pro est destiné pour la fabrication d'attelles et de gouttières pour la correction des malocclusions. Grâce à sa résistance initiale optimale et à ses excellentes propriétés élastiques, CA® Pro est idéal pour les applications à court terme dans les traitements orthodontiques modernes...

- Grande élasticité et résistance à la rupture grâce à une couche d'élastomère flexible
- Transmission continue de la force, perte minimale de force
- Grand confort de port grâce à une force initiale souple
- Également disponible : CA® Pro+ avec film isolant intégré



3640 CA® Pro 0,5mm
3641 CA® Pro 0,625mm
3642 CA® Pro 0,75mm
3644 CA® Pro+ 0,5mm
3645 CA® Pro+ 0,625mm
3646 CA® Pro+ 0,75mm
10 pcs

BLUE BLOKKER®

5276 4x1,5g Blue Blokker



BIOPERM TRIMMER

3226 2 pcs Bioperm Trimmer Blue



CUTTING BUR

3214 6 pcs Cutting burs



OSAMU POLISHER GREY

3247 2 pcs Osamu Polishers Grey



SECURITY KEY for expansion screws

2100 10 pcs



KEY for expansion screws

2101 100 pcs



Alle producten van Scheu zijn verkrijgbaar !
Tous les produits Scheu sont disponibles !

CAVEX

VACUFORMER KIT VF001

Kit Including:

- 1 CAVEX VacuFormer
- 1 Pair of Scissors
- 6 Base Trays
- 12 Mouth Protector
- 25 Splint-Trays 1 mm
- 25 Bleach-Trays 1 mm
- 18 Sets Instant Stone



CAVEX

SPLINT FOILS

VT028 Cavex Splint 1mm 25 sheets

VT026 Cavex Splint 1.5mm 25 sheets



CAVEX

INSTANT STONE

VT010 1x72 pcs Stone + Activator



CAVEX

GREENCLEAN

HA001 1x 1kg GreenClean



FUJIROCK® EP PREMIUM

890366 Polar White
Pack/4 Kg



PLASTER SPATULA

AT060 1 pc



CAVEX BOWL

AT041 Blue



MIRACAST

Miracast medium
203067 Lower
203068 upper



CAVEX SET UP WAX

WA002

Cavex Set Up Wax Regular FLEX
23 sheets

WA004

Cavex Set Up Soft Modelling Wax
23 sheets

WA005

Cavex Set Up Regular Modelling Wax
23 sheets



GEORGE GAUGE™ Bite Registration

For simple and precise registration of occlusion in snoring therapy and orthodontics. The bite registration is pre-adjusted using 2 or 5 mm bite forks.

5471 Bite Registration set comes with 3 bite forks (1 for each size)

5472 Bite fork, 10 pieces, 2mm, grey, small (S)

5473 Bite fork, 10 pieces, 5mm, white, small (S)

5462 Bite fork, 10 pieces, 5mm, white, large (L)

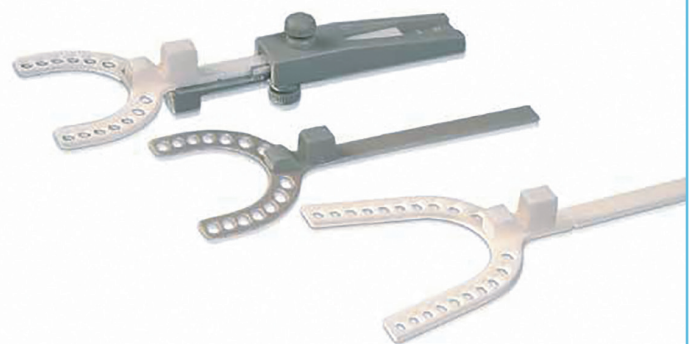

ORTHOPEDIC WAX BITES

Small bite registration waxes.
OW40019
non-sterile wax
28 pcs/box



UTILITY WAX WHITE, ROUND

UW40003
64 strips/box
white



PEDO CURVED SCISSORS

DB05-0331 1x pair scissors



HYGENIC BLUE BITE WAFERS W/FOIL

H00825 Bite Wafers
with foil 24 pcs



WAX KNIFE



DBL5-0104 1 pc



DBL5-0110 1 pc



ICONIC PRO RESERVOIR LC

DBL2-0002 Iconic Pro Reservoir LC -
2 x 2ml syringes & 6 mixing tips.



- Quick curing time.
- No waxy residue - smear layer.
- Very smooth even finish so no additional working required.
- Cures with halogen or UV light.



WHEEL SAW

DBL4-0150 1x Wheel Saw

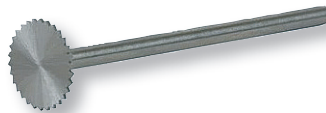

POLISHING DISCS

4S04-1381 Iconic Fine White
4S04-1382 Iconic Medium Grey
4S04-1384 Iconic Coarse Brown
5 pcs/pack



ICONIC ORIGINAL RETAINER MATERIAL

- Brilliantly clear and rigid when formed.
- Accepts bonding materials.
- Perfect for orthodontic retainers, aligners for minor tooth movement, occlusal splints, and bruxism splints.
- Protective clear foil on both sides.
- Clear foil can be used as spacer when forming retainer (heat resistant).
- No need to insulate model when using clear foil.



Sold in packs of 50

	120 mm Round clear	5" Square clear	125 mm Round clear
0.75 mm	DBL3-0602	DBL3-0600	DBL3-0601
1 mm	DBL3-0605	DBL3-0603	DBL3-0604
1.5 mm	DBL3-0608	DBL3-0606	DBL3-0607

RETAINER BOXES



Retainer Boxes	Mini 1"	Max 1.5"
Sparkle Aqua	DB04-4001	DB04-4101
Tropical Pink	DB04-4007	DB04-4107
Sparkle Black	DB04-4002	DB04-4102
Tropical Orange	DB04-4008	DB04-4108
Tropical Blue	DB04-4009	DB04-4109
Sparkle Green	DB04-4004	DB04-4104
Tropical Green	DB04-4010	DB04-4110
Sparkle Purple	DB04-4005	DB04-4105
White Splash	DB04-4012	DB04-4112
Sparkle Red	DB04-4006	DB04-4106
White	DB04-4014	DB04-4114
Sparkle Assorted (excludes white splash and white)	DB04-4000	DB04-4100

2 sizes:

- Mini 1" Retainer Boxes
- Max 1.5" Retainer Boxes

Sold in packs of 10 (1 colour or sparkle assorted)

AIRSONIC® MINI SANDBLASTER

401080

with standard nozzle 60° and 20 g powder

605084 Airsonic - Aluminum Oxide,
50 Micro, Powder for Sandblasting, 500 g



AIRSONIC® ADAPTER

401084 a.

Adapter K for a direct connect
to Kavo unit



401089 b.

Adapter S for a direct connection
to Sirona Titane unit



401077 c.

Connection to W + H Rotoquick



401076 d.

Connection to Bien Air Unifix



401090 e.

Connection to EMS-box



401091 f.

Connection to lab unit



AIRSONIC® ABSORBO BOX

- No separate aspiration system required
- Ideal for working in combination with the mini sandblaster
- Size (W x H x D): 35.6 cm x 22 cm x 37 cm
- Weight: Only 2.8 kg

401082

Airsonic Absorbo Box

401092

Replacement filter separately

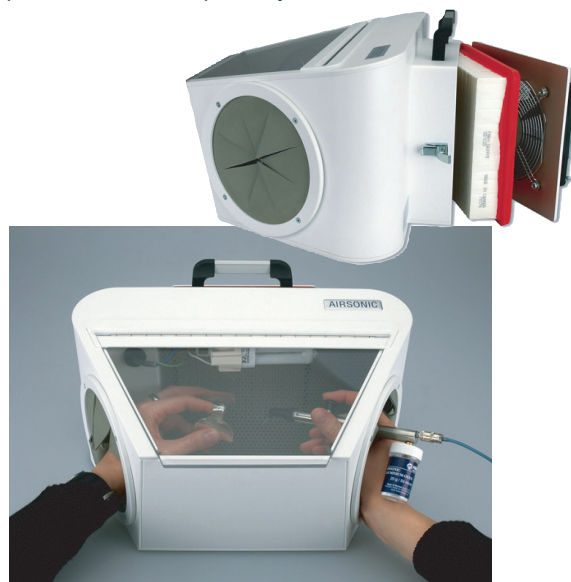

MIRATOR 2000E

Electronically adjustable vibrator

- Continuously variable to up to 6,000 vibrations/min.
- Sturdy and powerful
- Worktop available separately upon request

Worktop: approx. 13 x 15 cm
 Voltage: 23 V - 50/60 Hz
 Power consumption: max. 200 W
 Safety fuse: 1 A
 Weight: 3.5 kg

401350 1 pc Mirator 2000E



ATOMIUM coated metal burs



DBL4-0103 1 pc
A Shape Fine Cut



DBL4-0104 1 pc
B Shape Fine Cut

BIG BURTHA Coated Mouthguard Bur

Big Burtha can be used to trim mouthguard, both cold and heat cure acrylics leaving a smooth finish which is easily polished

DBL4-0005
1 pc Big Burtha



MICROMOTOR MHC

Compact en ergonomisch

Leuk en modern ontwerp
 Geïntegreerd handstuk- en freeshouder

Eenvoudige bediening

Snelheidsregeling op het toestel of via de voetpedaal voor variabele snelheid, omkeren van de draairichting

Aangenaam

Stil, zonder trillingen of warmteafgifte, zelfs bij intensief gebruik

Compact et ergonomique

Design agréable et moderne
 Support de pièce à main et de fraises intégré

Utilisation simple

Contrôle de la vitesse sur l'unité ou par la pédale à vitesse variable Inversion du sens de rotation

Agréable

Silencieux sans vibration ni émission de chaleur même en cas d'utilisation intensive

MHC 200A

geheel met labo handstuk - ensemble avec pièce à main labo

MHC 201A

labo handstuk - pièce à main labo

MHC 202B

Motor-Moteur Type - E



	Handstuk Pièce à main	Motor - Moteur type-E
Snelheid - Vitesse	0 ~ 35.000	0 ~ 40.000
Koppeling - Couple	2,8 N.cm	2,8 N.cm
Power - Puissance	DC 12V - 45 W	DC 12V - 45 W
Gewicht - Poids	208 gr	160 gr
Afmeting - Dimension (mm)	L 154 - D 27,5	L 70 - D 23,7
Stroomvoorziening - Alimentation	AC 230 V - 50 Hz	AC 230 V - 50 Hz
Gewicht - poids de l'unité	1,45 kg	1,45 kg



Wire bending machine for your fixed retainer

BENDER II

**Fixed
retainer
in 10 min.**



Tijdbesparend

Geen tweede bezoek voor het kleven van een retainer

Gain de temps

Pas de deuxième visite pour le collage d'un fil de contention



Kostenbesparend

Geen gips meer en ook geen labokosten meer

Réduction des coûts

Plus de plâtre et plus de frais de laboratoire



2 bezoeken in 1 keer

Debondeer de brackets en plaats de retainer 10 à 15 min later

2 visites en 1 fois

Débaguez les brackets et placez le fil de contention après 10 à 15 min

* 2 jaar garantie ** 3 jaar garantie Afmeting/Taille: 400x245x285mm
* garantie 2 ans ** garantie 3 ans Gewicht/Poids: 16kg

Model	Shape	Type SS	Size(stand)	Size (opt)
Ben-II-O round type		Twisted SS	0.0175 545-745-00	0.0195 545-750-00
Ben-II-O rectangle type		Rectangle SS	0.016x0.022 537-310-00	-
		Square SS	0.016x0.016 537-340-00	-

Sneller en efficiënter met de Bender II / Plus rapide et efficace avec le Bender II



3D scanning (3min)
Numérisation 3D (3min)

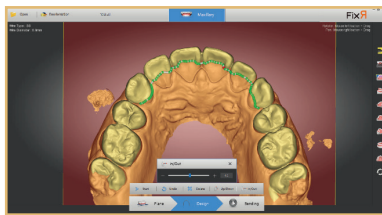

Ontwerp van de draad (2min)
Conception du fil (2min)



Plooiën van de draad (5min)
Pliage du fil (5min)

Gemakkelijk en eenvoudig met de software FixR & BendR / Simple et facile avec le logiciel FixR & BendR

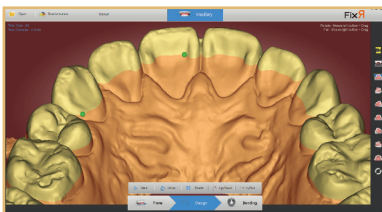

Geef 3 punten aan
Indiquez 3 points



Ontwerp door de FixR
Design par le FixR

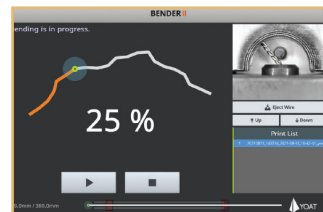

Plooiën door de BendR
Pliage par le BendR





Mini-implants/ Mini-implants

INFINITAS INTRO KIT

DB10-0063 Sterile implants

The Infinitas Intro Kit contains:

- Infinitas sterilisation tray
- Standard handle
- Standard inserts: Screwdriver, Mucotome, Bone punch
- 5 mini implants (includes 1 of each sterile implant)

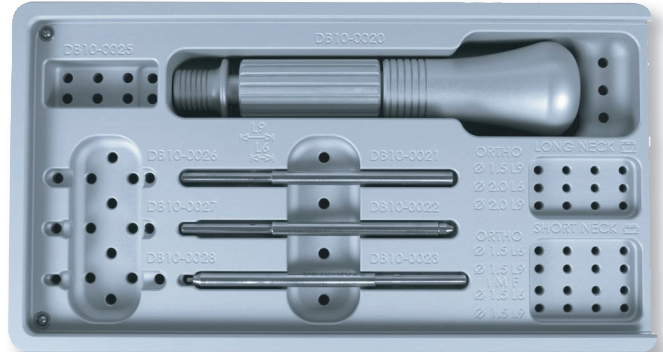

MINI IMPLANT

Blue - Sterile

DB10-0010 1 pc sterile implant

- Diameter - 1.5mm
- Body - 9mm
- Neck - Short
- Typically used for Buccal sites

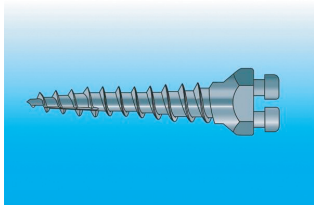

MINI IMPLANT

Green - Sterile

DB10-0016 1 pc sterile implant

- Diameter - 2mm
- Body - 9mm
- Neck - Long
- Typically used for Edentulous areas

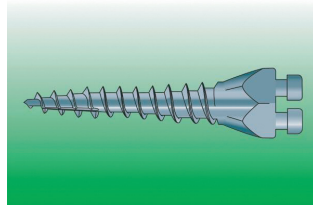

MINI IMPLANT

Magenta - Sterile

DB10-0009 1 pc sterile implant

- Diameter - 1.5mm
- Body Length - 6mm
- Neck - Short
- Used for Incisor sites

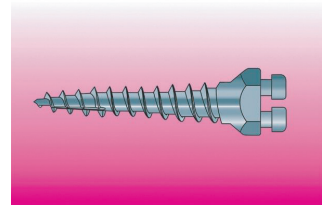

MINI IMPLANT

Purple - Sterile

DB10-0012 1 pc sterile implant

- Diameter - 1.5mm
- Body - 9mm
- Neck - Long
- Typically used for Alveolar Sites

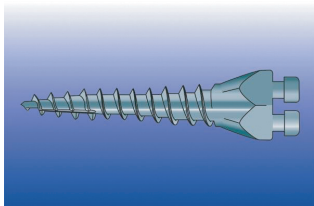

MINI IMPLANT

Yellow - Sterile

DB10-0015 1 pc sterile implant

- Diameter - 2mm
- Body - 6mm
- Neck - Long
- Typically used for Alveolar Sites

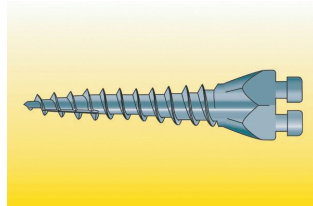

Voor meer informatie gelieve contact op te nemen met B-Dental.

Pour plus d'informations, veuillez contacter B-Dental.

Mini-implants/Mini-implants

INFINITAS MINI IMPLANT



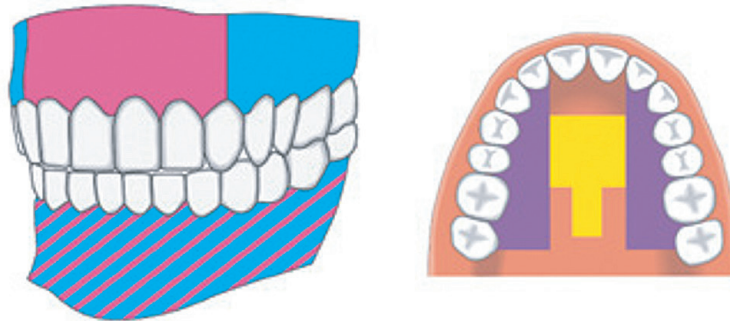

Selecting the correct Infinitas Mini Implant. The Infinitas System can be used to provide bone anchorage in virtually any maxillary/mandibular interproximal site and in the hard palate, although the most frequently utilised insertion site is buccal and mesial to the maxillary first molar. The insertion site is determined by individual anchorage demands and anatomical factors (e.g. bone quantity, root and sinus positions). The exact insertion site is selected by studying each patient's dental model and radiographs (OPT and/or periapical views) together. General guidelines for usage are:



 DB10-0001/9 and DB10-0002/10 may be used in this area.

 Not shown in diagram as used in Edentulous areas.

The insertion sites shown are intended for guidance only.

Colour coded	Diameter (mm)	Body Length (mm)	Neck	Sterile	Typical Insertion sites
	1.5	6	Short	DB10-0009	Anterior maxilla - perpendicular insertions Mandible - perpendicular insertions
	1.5	9	Short	DB10-0010	Anterior maxilla - oblique insertions, Posterior maxillary buccal alveolus, Mandible - oblique insertions
	1.5	9	Long	DB10-0012	Maxilla - palatal alveolus
	2.0	6	Long	DB10-0015	Mid-palate
	2.0	9	Long	DB10-0016	Edentulous areas Temporary restorative abutment

CRIMPABLE CURVED MULTI HOOK

Verpakt per 10 / Emballé par 10 pcs

430-019 Right

430-020 Left

